

dello[®]
A marca da organização

PROTEA
by dello. assinatura da casa

REALIZAÇÃO

é tempo de colher os frutos!

CATÁLOGO
DE PRODUTOS
2025

o que podemos realizar hoje?



TABELA DE CORES

A AMARELO / AMARILLO	LV LAVANDA	GG NUDE E NUDE / GRIS Y GRIS
AU OURO / ORO	M MARROM / MARRÓN	GG1 NUDE E GRAFITE / GRIS Y GRAFITO
B AZUL CLARO	O PRATA / PLATA	HCP CRISTAL E CAPPUCCINO / CRISTAL Y CAPPUCCINO
BR AZUL ROYAL	P PRETO / NEGRO	HE CRISTAL E BRANCO / CRISTAL Y BLANCO
C AZUL	Q PINK / ROSA	HG CRISTAL E NUDE / CRISTAL Y GRIS
CB COBRE	R ROXO / VIOLETA	HG1 CRISTAL E GRAFITE / CRISTAL Y GRAFITO
CP CAPPUCCINO	RG ROSÉ GOLD / ROSA GOLD	HLP CRISTAL E LILÁS PASTEL / CRISTAL Y LILA PASTEL
D BEGE / BEIGE	S SORTIDO / SURTIDO	HW CRISTAL E ROSA / CRISTAL Y ROSA
DR DOURADO / DORADO	SE SORTIDO EXECUTIVE / SURTIDO EJECTIVE	HW2 CRISTAL E ROSA CLARO / CRISTAL ROSA CLARO
E BRANCO / BLANCO	SM SORTIDO METALIZADO / SURTIDO METALIZADO	AP AMARELO PASTEL / AMARILLO PASTEL
F CASTANHO / MARRÓN NUEZ	T VERDE	BP AZUL PASTEL
FP FRESCOR DE PITANGA	U VERMELHO / ROJO	LP LILÁS PASTEL / LILA PASTEL
G CINZA NUDE / GRIS	V1 VERDE ESCURO / VERDE OSCURO	MP MAMÃO PAPAYA / PAPAYA
G1 GRAFITE / GRAFITO	VL VERDE LIMÃO / VERDE LIMÓN	SS SORTIDO SERENA / SURTIDO SERENA
G2 CHUMBO / CÔR DE PLOMO	VO VERDE OLIVA	VP VERDE PASTEL
H CRISTAL	W ROSA CLARO	WP ROSA PASTEL
I FUMÊ / AHUMADO	W2 ROSA LIGHT	
K LARANJA / NARANJA	X KRAFT	

dello[®]
A marca da organização

Delo Indústria e Comércio Ltda.

CNPJ 01.856.241/0001-08 • I.E. 251.674.233.0088

Estrada Municipal Remígio Olivotti, 1145 • Bairro Barreiro
Extrema/MG • CEP 37647-004 • Fone: +55 (35) 3435-8900

 www.dello.com.br

  [organizecomdello](#)

SEMPRE EM FRENTE

Nos últimos dois anos, em virtude da comemoração do quinquagênio da Dello, acompanhamos a saga do elefante. Um mergulho em nossos ideais que serviu como um ritual de passagem para uma nova fase. Voltamos ao nosso passado, à magia que nos une a um saudoso sentimento de algo que nos acompanha desde a infância; afinal, estamos juntos há mais de 50 anos.

Esse mundo mágico de sensações e emoções teve um personagem central que personifica a luta diária para manter-se firme através dos anos: o elefante. Nosso sonhador protagonista, que mirava o horizonte, é um símbolo da perseverança e da persistência, caminhando sempre à frente até o seu objetivo.

O elefante chega hoje ao seu ponto final como um sinal de conquista, de realização, e como um sinal dos novos tempos, em busca de novos

objetivos. Este ponto final precede o início de um novo parágrafo, uma nova caminhada, munidos de nossos sonhos e nossa perseverança, para que, com persistência, continuemos sempre à frente.

Nesta nova caminhada, a Dello está de roupa nova! Adoramos o calmo azul, que transmite confiança, mas queremos mostrar que somos mais. Queremos o calor do laranja com o seu dinamismo e criatividade; uma cor que mostra a que veio: vibrante e cheia de si, inovadora, acolhedora e envolvente; uma cor que não fica parada. Acrescentamos a ela um toque do apaixonante vermelho, outra cor vibrante e que aproxima as pessoas com tanta intensidade.

Tudo isso reflete quem somos: uma empresa comprometida em oferecer produtos que não apenas encantam visualmente, mas também estimulam os sentidos e organizam o seu dia a dia.





Clique na
seção desejada

ÍNDICE

ESCOLAR

AROMAS	6
FULL COLOR	8
DOÇURA MUNDO DA LUA	16
SERENA	17
SECRETS	23
TOP LINE	25
LINE	29
FINE	33
CAIXAS ORGANIZADORAS	35
POLIDELLO	36
DELLOPLEX	38
RÉGUAS	39
RÉGUAS - POTÊNCIA	40
RÉGUAS - ECONÔMICA	42
RÉGUAS - FLEXÍVEIS PP	44
PRANCHETA	46

OFFICE

EXECUTIVE	48
DELLOPLAST	53
TAPETE / DESK / MOUSE	54
CAIXAS ARQUIVOS	55
QUADROS DE AVISOS	56
PASTAS CLASSIFICADORAS	58
DELLOCLASSIC	60
PASTAS SUSPENSAS	62
ACESSÓRIOS	67
MALETAS	68
ORGANIZAÇÃO OFFICE	71

HOME

COSMÉTICOS / SOUL	77
CAIXAS ORGANIZADORAS	81
CAIXAS / GABARITOS	83
CESTOS	85
FORROS	86
FICHA TÉCNICA	87

CATÁLOGO 2025

ESCOLAR





Cherry
0470.01

Morango
0470.02

Brigadeiro
0470.03

Jasmim
0470.04

Café
0470.05

0470

Pasta Aba Elástico A4 Aromas
Carpeta Ala Elástico A4 Aromas

C.L.A. 310 x 0 x 220 mm
 Espessura 0,4 mm

01	30 un.	02	30 un.
03	30 un.	04	30 un.
05	30 un.	S	30 un.

- Possuem aromas de Cereja, Morango, Brigadeiro, Jasmim e Café.
- Estampas temáticas em verniz brilhante.
- Terminação do elástico em plástico. Não oxida, não enferruja, não causa danos como corte e não passa oxidação para as folhas de papel.



Cherry
0015.01

Morango
0015.02

Brigadeiro
0015.03

Jasmim
0015.04

Café
0015.05

0015

Envelope c/ Botão A4 Aromas
Sobre con Botón A4 Aromas

C.L.A. 330 x 0 x 240 mm
 Espessura 0,2 mm

01	30 un.	02	30 un.
03	30 un.	04	30 un.
05	30 un.	S	30 un.

- Possuem aromas de Cereja, Morango, Brigadeiro, Jasmim e Café.
- Estampas temáticas em verniz brilhante.





Cherry
0470.01



Morango
0470.02





Brigadeiro
0470.03

0685

Porta Documentos A4 Aromas

Porta Documentos A4 Aromas

 C.L.A. 175 x 0 x 120 mm

 Espessura 0,4 mm

01 30 un. **02** 30 un.
03 30 un.



- Possuem aromas de Cereja, Morango e Brigadeiro.
- Estampas temáticas em verniz brilhante.
- Terminação do elástico em plástico. Não oxida, não enferruja, não causa danos como corte e não passa oxidação para as folhas de papel.

AROMAS

ESCOLAR



Cherry
6108.01



Morango
6108.02





Brigadeiro
6108.03

6108

Pasta Sanfonada A4 Aromas c/ 12 Divisórias

Carpeta Acordeón A4 Aromas con 12 Divisiones

 C.L.A. 331 x 32 x 244 mm

 Espessura 0,8 mm

01 6 un. **02** 6 un.
03 6 un.



- Possuem aromas de Cereja, Morango, Brigadeiro, Jasmin e Café.
- Solda resistente. O miolo não solta.
- Terminação do elástico em plástico. Não oxida, não enferruja, não causa danos como corte e não passa oxidação para as folhas de papel.



Cherry
3020.01

Morango
3020.02

Brigadeiro
3020.03

Jasmin
3020.04

Café
3020.P



3020

Porta Objetos c/ 3 Divisórias Aromas

Porta Objetos con 3 Divisiones Aromas

 C.L.A. 112 x 112 x 94 mm

- 01 6 un.
- 02 6 un.
- 03 6 un.
- 04 6 un.
- P 6 un.

- Ultrarresistente.
- Com cores temáticas para combinar.



Cherry
3116.01

Morango
3116.02

Brigadeiro
3116.03

Jasmim
3111.E

Café
3111.P



3116

Régua 30 cm Aromas

Reglas 30 cm Aromas

 C.L.A. 310 x 34 x 3 mm

- 01 96 un.
- 02 96 un.
- 03 96 un.
- E 96 un.
- P 96 un.

- Possui apoio para os dedos para maior firmeza e precisão.
- Com cores temáticas para combinar.
- Ultrarresistente.



FULL COLOR

ESCOLAR



71427321893



0440

Pasta Aba Elástico 1/2 Ofício Full Color

Carpeta Ala Elástico 1/2 Ofício Full color

 C.L.A. 245 x 0 x 180 mm  50 un. 50 un. 50 un. 50 un. 50 un. 50 un.

 Espessura 0,35 mm



- Cores vibrantes com combinações especiais.
- Terminação do elástico em plástico. Não oxida, não enferruja, não causa danos como corte e não passa oxidação para as folhas de papel.

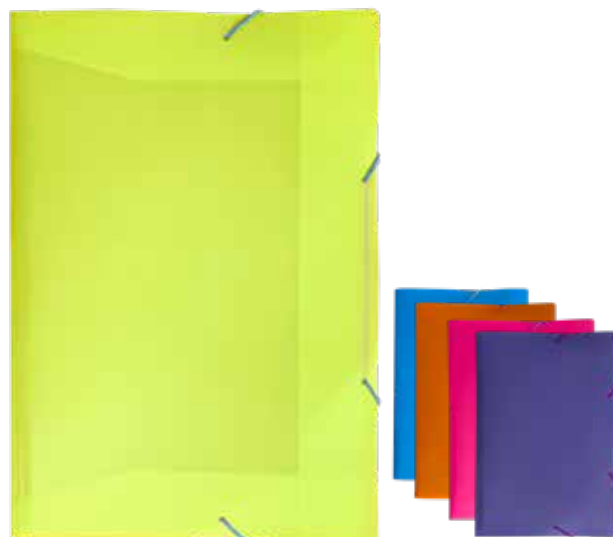

0442

Pasta Aba Elástico A4 Full Color

Carpeta Ala Elástico A4 Full color

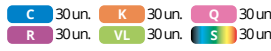
 C.L.A. 310 x 0 x 220 mm  30 un. 30 un. 30 un. 30 un. 30 un. 30 un.

 Espessura 0,4 mm



- Cores vibrantes com combinações especiais.
- Terminação do elástico em plástico. Não oxida, não enferruja, não causa danos como corte e não passa oxidação para as folhas de papel.



0438

Pasta Aba Elástico A4 Lombo 2 cm Full Color

Carpeta Ala Elástico A4 Lomo 4 cm Full color

 C.L.A. 310 x 20 x 220 mm  30 un. 30 un. 30 un.

 Espessura 0,45 mm



- Cores vibrantes com combinações especiais.
- Terminação do elástico em plástico. Não oxida, não enferruja, não causa danos como corte e não passa oxidação para as folhas de papel.



0439

Pasta Aba Elástico A4 Lombo 4 cm Full Color

Carpeta Ala Elástico A4 Lomo 4 cm Full color

 C.L.A. 310 x 40 x 220 mm  30 un. 30 un. 30 un.

 Espessura 0,55 mm



- Cores vibrantes com combinações especiais.
- Terminação do elástico em plástico. Não oxida, não enferruja, não causa danos como corte e não passa oxidação para as folhas de papel.

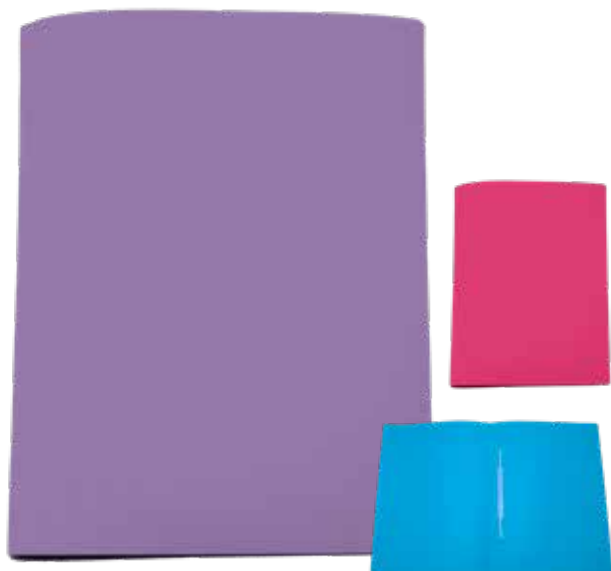

0296

Pasta Grampo Ofício Full Color

Carpeta Grapa Oficio Full Color

C.L.A. 335 x 0 x 245 mm C 50un. Q 50un. R 50un.

— Espessura 0,5 mm



- Cores vibrantes com combinações especiais.
- Com grampo plástico instalado.
- Ideal para uso escolar.



2164

Maleta Ofício Full Color

Maleta Oficio Full Color

C.L.A. 360 x 43 x 260 mm C 5un. Q 5un.

— Espessura 0,9 mm



- Alça anatômica.
- Cores vibrantes com combinações especiais.
- Com porta canetas.
- Terminação do elástico em plástico. Não oxida, não enferruja, não causa danos como corte e não passa oxidação para as folhas de papel.

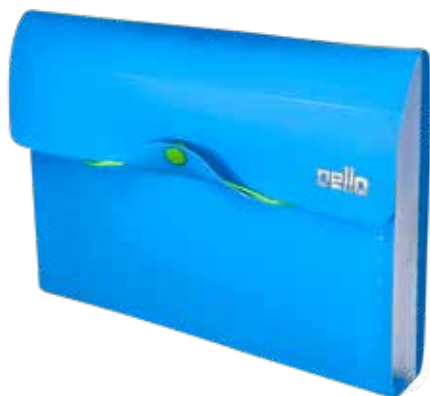

6106

Pasta Sanfonada Mini Full Color c/ 12 Divisórias

Carpeta Acordeón Mini Full Color con 12 Divisiones

C.L.A. 250 x 31 x 182 mm C 12un. K 12un. Q 12un. R 12un.

— Espessura 0,6 mm



- Botão de coração para as cores laranja, rosa e roxo.
- Solda resistente. O miolo não solta.
- Cores vibrantes com combinações especiais.
- Terminação do elástico em plástico. Não oxida, não enferruja, não causa danos como corte e não passa oxidação para as folhas de papel.



6107

Pasta Sanfonada A4 Full Color c/ 12 Divisórias

Carpeta Acordeón A4 Full Color con 12 Divisiones

C.L.A. 331 x 32 x 244 mm C 12un. K 12un. Q 12un. R 12un. VL 12un. S 12un.

— Espessura 0,6 mm



- Botão de coração para as cores laranja, rosa e roxo.
- Solda resistente. O miolo não solta.
- Cores vibrantes com combinações especiais.
- Terminação do elástico em plástico. Não oxida, não enferruja, não causa danos como corte e não passa oxidação para as folhas de papel.



5037

Pasta Fichário A4 c/ 4 Argolas Full Color
Carpeta Argolada Ofício 4 Anillos Full Color

📏 C.L.A. 345 x 57 x 260 mm **C** 6un. **Q** 6un. **R** 6un.
➦ Espessura 0,9 mm



- Cores vibrantes com combinações especiais.
- Capacidade para 200 folhas.
- Possui elástico para fechamento.



0014

Envelope c/ Botão A4 Full Color
Sobre con Botón A4 Full Color

📏 C.L.A. 330 x 0 x 240 mm **C** 30un. **K** 30un. **Q** 30un.
➦ Espessura 0,2 mm **R** 30un. **VL** 30un. **S** 30un.



- Botão de coração para as cores laranja, rosa e roxo.
- Cores vibrantes com combinações especiais.



6029.01

Arquivo Full Color c/ 5 Envelopes Coloridos
Archivo Full Color c/ 5 Sobres Color

📏 C.L.A. 340 x 90 x 250 mm 05un.



- Modelo exclusivo.
- Botão de coração para as cores laranja, rosa e roxo.
- Cores vibrantes com combinações especiais.



FULL COLOR



ESCOLAR

71427321893

71427321893



8805
Estojo Multiuso Full Color
Estuche Multiuso Full Color

 C.L.A. 200 x 30 x 70 mm C 30 un. Q 30 un. R 30 un.
 Espessura 0,2 mm



- Cores vibrantes.



3115
Régua 30 cm Full Color
Reglas 30 cm Full Color

 C.L.A. 310 x 34 x 3 mm

Solapa Individual.		Caixa Display	
C 96 un.	Q 96 un.	SFL 100 un.	
R 96 un.	VL 96 un.		



- Possui apoio para os dedos para maior firmeza e precisão.
- Cores vibrantes.
- Ultrarresistente.



Azul e Verde Limão
2299.01

Pink e Roxo
2299.02

2299
Kit Duo Full Color Azul/Verde Limão
Kit Duo Full Color Azul/Verde Limão

 C.L.A. 156 x 81 x 98 mm 01 6 un. 02 6 un.



- Acompanha cartela de adesivos.
- Cores vibrantes com combinações especiais.



6513
Kit c/ 3 Porta Objetos Full Color
Kit con 3 Porta Objetos Full Color

 C.L.A. 80 x 76 x 210 mm

C 8 un.	Q 8 un.
R 8 un.	VL 8 un.



- Ultrarresistente.
- Cores vibrantes.

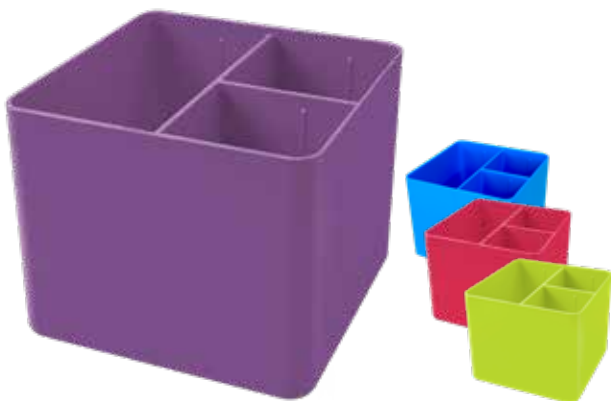

3020

Porta Objetos c/ 3 Divisórias Full Color

Porta Objetos con 3 Divisiones Full Color

 C.L.A. 112 x 112 x 94 mm

C 6 un. **Q** 6 un.
R 6 un. **VL** 6 un.



- Ultrarresistente.
- Cores vibrantes.



FULL COLOR

ESCOLAR



3009

Prancheta 1/2 Ofício Full Color

Tabla 1/2 Ofício Full Color

 C.L.A. 255 x 160 x 40 mm

 Espessura 3 mm

C 12 un. **K** 12 un.
Q 12 un. **R** 12 un.



- Cores vibrantes com combinações especiais.
- Prendedor em PS, não marca o papel.
- Réguas na lateral e embaixo e transferidor de 90°.



3007

Prancheta Ofício Full Color

Tabla Ofício Full Color

 C.L.A. 360 x 240 x 40 mm

 Espessura 3 mm

C 12 un. **K** 12 un.
Q 12 un. **R** 12 un.



- Cores vibrantes com combinações especiais.
- Prendedor em PS, não marca o papel.
- Réguas na lateral e embaixo e transferidor de 90°.



0272.02

Pasta Aba Elástico A4 Panda Verde

Carpeta Ala Elástico Ofício Panda Verde

 C.L.A. 335 x 0 x 235 mm

30 un.

 Espessura 0,45 mm



- Exclusiva estampa de panda.
- Terminação do elástico em plástico, não oxida, não enferruja, e não causa danos como corte, não passa a oxidação para as folhas de papel



0018.02

Envelope c/ Botão A4 Panda Verde

Sobre con Botón A4 Panda Verde

 C.L.A. 330 x 0 x 240 mm

30 un.

 Espessura 0,2 mm





- Exclusiva estampa de panda.
- Alta durabilidade.
- Botão resistente.









2190
Kit Doçura c/ 5 Porta Objetos
Kit Doçura con 5 Porta Objetos

 C.L.A. 390 x 90 x 100 mm  6un.

- Top entre os mais vendidos.
- Base pode ser presa na parede.
- Acompanha cartela de adesivos.



2191
Kit Mundo Da Lua c/ 5 Porta Objetos
Kit Mundo Da Lua con 5 Porta Objetos

 C.L.A. 390 x 90 x 100 mm  6un.

- Base pode ser presa na parede.
- Acompanha cartela de adesivos.





2290
Mini Kit Doçura c/ 4 Porta Objetos
Mini Kit Doçura con 4 Porta Objetos

 C.L.A. 310 x 85 x 55 mm  6un.

- Base pode ser presa na parede.
- Acompanha cartela de adesivos.



2291
Mini Kit Mundo Da Lua c/ 4 Porta Objetos
Mini Kit Mundo Da Lua con 4 Porta Objetos

 C.L.A. 310 x 85 x 55 mm  6un.

- Base pode ser presa na parede.
- Acompanha cartela de adesivos.





0277

Pasta Aba Elástico 1/2 Ofício Linho Serena

Carpeta Ala Elástico 1/2 Ofício Lino Serena

 C.L.A. 245 x 0 x 180 mm  50 un.  50 un.  50 un.

 50 un.  50 un.

 Espessura 0,4 mm





- Tons pastel, que lembram marshmallow.
- Textura de linho.
- Terminação do elástico em plástico, não oxida, não enferruja, e não causa danos como corte, não passa a oxidação para as folhas de papel



0278

Pasta Aba Elástico 1/2 Ofício Lombo 2,5 cm Linho Serena

Carpeta Ala Elástico 1/2 Ofício Lomo 2,5 cm Lino Serena

 C.L.A. 245 x 25 x 180 mm  50 un.  50 un.  50 un.

 50 un.  50 un.

 Espessura 0,45 mm

- Tons pastel, que lembram marshmallow.
- Textura de linho.
- Terminação do elástico em plástico, não oxida, não enferruja, e não causa danos como corte, não passa a oxidação para as folhas de papel



0246

Pasta Aba Elástico Ofício Linho Serena

Carpeta Ala Elástico Ofício Lino Serena

 C.L.A. 335 x 0 x 235 mm  50 un.  50 un.  50 un.

 50 un.  50 un.

 Espessura 0,5 mm





- Tons pastel, que lembram marshmallow.
- Textura de linho.
- Terminação do elástico em plástico, não oxida, não enferruja, e não causa danos como corte, não passa a oxidação para as folhas de papel



0247

Pasta Aba Elástico Ofício Lombo 2 cm Linho Serena

Carpeta Ala Elástico Ofício Lomo 2 cm Lino Serena

 C.L.A. 335 x 20 x 235 mm  50 un.  50 un.  50 un.

 50 un.  50 un.

 Espessura 0,5 mm

- Tons pastel, que lembram marshmallow.
- Textura de linho.
- Terminação do elástico em plástico, não oxida, não enferruja, e não causa danos como corte, não passa a oxidação para as folhas de papel











0248

Pasta Aba Elástico Ofício Lombo 3 cm Linho Serena

Carpeta Ala Elástico Ofício Lomo 3 cm Lino Serena

 C.L.A. 335 x 30 x 235 mm  50 un.  50 un.  50 un.  50 un.

 Espessura 0,6 mm









- Tons pastel, que lembram marshmallow.
- Textura de linho.
- Terminação do elástico em plástico, não oxida, não enferruja, e não causa danos como corte, não passa a oxidação para as folhas de pape



0249

Pasta Aba Elástico Ofício Lombo 4 cm Linho Serena

Carpeta Ala Elástico Ofício Lomo 4 cm Lino Serena

 C.L.A. 335 x 40 x 235 mm  50 un.  50 un.  50 un.  50 un.  50 un.

 Espessura 0,6 mm







- Tons pastel, que lembram marshmallow.
- Textura de linho.
- Terminação do elástico em plástico, não oxida, não enferruja, e não causa danos como corte, não passa a oxidação para as folhas de pape



0250

Pasta Aba Elástico Ofício Lombo 5,5 cm Linho Serena

Carpeta Ala Elástico Ofício Lomo 5,5 cm Lino Serena

 C.L.A. 335 x 55 x 235 mm  50 un.  50 un.  50 un.  50 un.

 Espessura 0,7 mm



- Tons pastel, que lembram marshmallow.
- Textura de linho.
- Terminação do elástico em plástico, não oxida, não enferruja, e não causa danos como corte, não passa a oxidação para as folhas de pape



0012

Envelope c/ Botão A4 Serena

Sobre con Botón A4 Serena

 C.L.A. 330 x 0 x 240 mm

 Espessura 0,2 mm

BP 30 un. LP 30 un. VP 30 un.
WP 30 un. SS 30 un.



- Tons pastel, que lembram marshmallow.
- Alta durabilidade.
- Botão resistente.

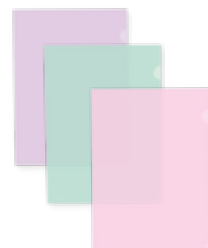

0270

Pasta L A4 Serena

Carpeta L A4 Serena

 C.L.A. 310 x 0 x 220 mm

 Espessura 0,15 mm

A 100 un. BP 100 un. C 100 un. H 100 un.
I 100 un. LP 100 un. T 100 un. U 100 un.
VP 100 un. WP 100 un. S 100 un. SS 100 un.



- Tons pastel, que lembram marshmallow.
- Solda resistente. Não solta.

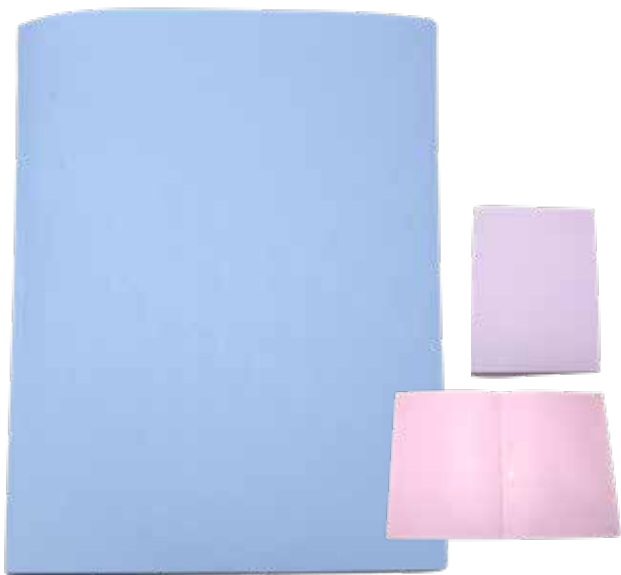

0295

Pasta Grampo Ofício Linho Serena c/ Grampo Plástico (Pacote c/ 10un.)

Carpeta Grapa Ofício Lino Serena con Grapa Plástica

 C.L.A. 335 x 0 x 245 mm

 Espessura 0,5 mm

BP 50 un. LP 50 un. WP 50 un.
S 50 un.



- Tons pastel, que lembram marshmallow.
- Com grampo plástico instalado.
- Ideal para uso escolar.



6035

Pasta Catálogo A4 Serena c/ 30 Plásticos

Carpeta Catálogo A4 Serena con 30 Plásticos

 C.L.A. 310 x 20 x 240 mm

 Espessura 0,7 mm



BP 20 un. LP 20 un. WP 20 un.
SS 20 un.



- Textura de linho.
- Tons pastel, que lembram marshmallow.
- Sacos plásticos antiestáticos (gofrados), facilita a inserção das folhas.











5036 Pasta Fichário PP Serena *Carpeta Argolada PP Serena*

 C.L.A. 310 x 40 x 240 mm  6 un.
 Espessura 0,9 mm

- Tons pastel, que lembram marshmallow.
 - Capacidade para 200 folhas.
 - Possui elástico para fechamento.
- 









8800 Estojo Multiuso Linho Serena *Estuche Multiuso Lino Serena*

 C.L.A. 200 x 30 x 70 mm  30 un.  30 un.  30 un.
 30 un.  30 un.  30 un.
 Espessura 0,6 mm

- Tons pastel, que lembram marshmallow.
 - Textura de linho.
- 







6096 Pasta Sanfionada A4 Linho Serena c/ 12 Divisórias *Carpeta Acordeón A4 Lino Serena con 12 Divisiones*

 C.L.A. 330 x 30 x 236 mm  12 un.  12 un.  12 un.
 12 un.  12 un.
 Espessura 0,7 mm

- Textura de linho.
 - Solda resistente. O miolo não solta.
 - Tons pastel, que lembram marshmallow.
 - Terminação do elástico em plástico. Não oxida, não enferruja, não causa danos como corte e não passa oxidação para as folhas de papel.
- 



6097 Pasta Sanfionada A4 Linho Serena c/31 Divisórias *Carpeta Acordeón A4 Lino Serena con 31 Divisiones*

 C.L.A. 330 x 70 x 250 mm  6 un.  6 un.  6 un.
 Espessura 0,8 mm

- Textura de linho.
 - Solda resistente. O miolo não solta.
 - Tons pastel, que lembram marshmallow.
 - Terminação do elástico em plástico. Não oxida, não enferruja, não causa danos como corte e não passa oxidação para as folhas de papel.
- 



5022

Pasta Fichário Injetado c/ 4 Argolas

Carpeta 4 Anillos

 C.L.A. 270 x 45 x 315 mm **BP** 6un. **LP** 6un. **WP** 6un.

- Tons pastel, que lembram marschmallow.
- Capa resistente.
- Acompanha estojo.
- Possui elástico para fechamento.



3043

Caixa Correspondência Articulável Dupla (chilincado)

Caja Correspondencia Articulable Doble

 C.L.A. 355 x 250 x 90 mm **BP** 6un. **LP** 6un. **WP** 6un.

 Espessura 2,15 mm

- Tons pastel, que lembram marschmallow.
- Ideal para a organização da mesa.



3114

Régua 30 cm Serena (cx. Display)

Reglas 30 cm Serena (cj. Display)

 C.L.A. 310 x 34 x 3 mm **SS** 100un.

- Caixa display, ideal para o PDV.
- Possui apoio para os dedos para maior firmeza e precisão.
- Tons pastel, que lembram marschmallow.
- Ultrarresistente.



3112

Régua 30 cm Serena (solapa individual)

Reglas 30 cm Serena

 C.L.A. 310 x 34 x 3 mm **AP** 96un. **BP** 96un. **LP** 96un. **VP** 96un. **WP** 96un. **SS** 120un.

- Possui apoio para os dedos para maior firmeza e precisão.
- Tons pastel, que lembram marschmallow.
- Ultrarresistente.





3020
Porta Objetos c/ 3 Divisórias
Porta Objetos con 3 Divisiones

C.L.A. 112 x 112 x 94 mm

BP 6 un. LP 6 un.
WP 6 un.



- Tons pastel, que lembram marshmallow.
- Ultrarresistente.



3006
Prancheta Ofício Serena
Tabla Oficio Serena

C.L.A. 360 x 240 x 40 mm

BP 12 un. LP 12 un. VP 12 un.
WP 12 un. SS 12 un.

Espessura 3 mm



- Tons pastel, que lembram marshmallow.
- Prendedor em PS, não marca o papel.
- Réguas na lateral e embaixo e transferidor de 90°.



3029
Porta Objetos DelloColor
Porta Objetos DelloColor

C.L.A. 80 x 77 x 97 mm

BP 12 un. LP 12 un. WP 12 un.

Espessura 2,1 mm



- Tons pastel, que lembram marshmallow.
- Ultrarresistente.



3019
Porta Objetos Pequeno (kit c/4 Peças)
Porta Objetos Pequeno (kit con 4 Piezas)

C.L.A. 82 x 77 x 52 mm

H 12 un. LP 12 un. WP 12 un.



- Tons pastel, que lembram marshmallow.
- Ultrarresistente.



2163

Maleta Ofício Secrets

Maleta Ofício Secrets

 C.L.A. 360 x 43 x 260 mm

 5un.  5un.  5un.

 Espessura 0,9 mm



- Alça anatômica.
- Exclusiva tecnologia com glitter.
- Com porta canetas.
- Terminação do elástico em plástico. Não oxida, não enferruja, não causa danos como corte e não passa oxidação para as folhas de papel.

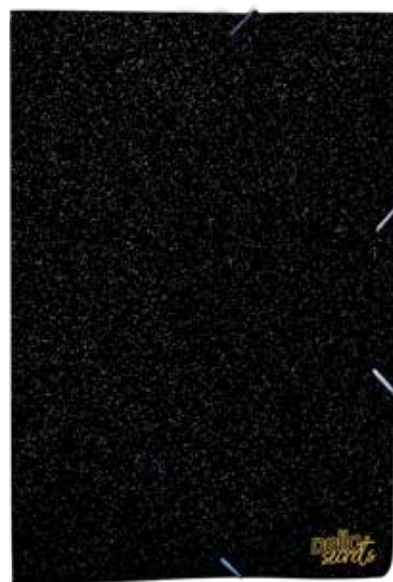

0274

Pasta Aba Elástico Ofício Secrets

Carpeta Ala Elástico Ofício Secrets

 C.L.A. 335 x 0 x 235 mm

 30un.  30un.  30un.

 Espessura 0,5 mm



- Exclusiva tecnologia com glitter.
- Terminação do elástico em plástico. Não oxida, não enferruja, não causa danos como corte e não passa oxidação para as folhas de papel.





SECRETS

ESCOLAR



0275

Pasta Aba Elástico Ofício Lombo 2 cm Secrets
Carpeta Ala Elástico Oficio Lomo 2 cm Secrets

 C.L.A. 335 x 20 x 235 mm  P 30 un.  W 30 un.  S 30 un.
 Espessura 0,5 mm





- Exclusiva tecnologia com glitter.
- Terminação do elástico em plástico. Não oxida, não enferruja, não causa danos como corte e não passa oxidação para as folhas de papel.



6091

Pasta Sanfonada A4 Secrets c/ 12 Divisórias
Carpeta Acordeón A4 Secrets con 12 Divisiones

 C.L.A. 331 x 32 x 242 mm  P 12 un.
 Espessura 0,6 mm









- Textura de linho.
- Solda resistente. O miolo não solta.
- Exclusiva tecnologia com glitter.
- Terminação do elástico em plástico. Não oxida, não enferruja, não causa danos como corte e não passa oxidação para as folhas de papel.



8801

Estojo Multiuso Secrets
Estuche Multiuso Secrets

 C.L.A. 200 x 30 x 70 mm  AU 30 un.  P 30 un.  W 30 un.
 S 30 un.
 Espessura 0,6 mm



- Exclusiva tecnologia com glitter.



0443

Pasta Aba Elástico Ofício Top Line Perolizada

Carpeta Ala Elástico Ofício Top Line Perlada

 C.L.A. 335 x 0 x 235 mm

H 30un. LP 30un.
WP 30un.

 Espessura 0,55 mm



- Textura Line.
- Acabamento perolizado brilhante.
- Terminação do elástico em plástico. Não oxida, não enferruja, não causa danos como corte e não passa oxidação para as folhas de papel.



0446

Pasta Aba Elástico Ofício Lombo 4cm Top Line Perolizada

Carpeta Ala Elástico Ofício Lomo 4 cm Top Line Perlada

 C.L.A. 335 x 40 x 235 mm

H 30un. LP 30un.
WP 30un.



 Espessura 0,75 mm



- Textura Line.
- Acabamento perolizado brilhante.
- Terminação do elástico em plástico. Não oxida, não enferruja, não causa danos como corte e não passa oxidação para as folhas de papel.





0233
Pasta Aba Elástico Ofício Top Line
Carpeta Ala Elástico Ofício Top Line

 C.L.A. 335 x 0 x 235 mm  A 50 un. C 50 un. H 50 un. I 50 un. Q 50 un. T 50 un. U 50 un. S 50 un.
 Espessura 0,55 mm

- Textura Line.
 - Mais resistente. Maior durabilidade
 - Terminação do elástico em plástico. Não oxida, não enferruja, não causa danos como corte e não passa oxidação para as folhas de papel.
- 





0234
Pasta Aba Elástico Ofício Lombo 2 cm Top Line
Carpeta Ala Elástico Ofício Lomo 2 cm Top Line

 C.L.A. 335 x 20 x 235 mm  C 50 un. H 50 un. I 50 un. Q 50 un. T 50 un. U 50 un. S 50 un.
 Espessura 0,65 mm

- Textura Line.
 - Mais resistente. Maior durabilidade
 - Terminação do elástico em plástico. Não oxida, não enferruja, não causa danos como corte e não passa oxidação para as folhas de papel.
- 





0235
Pasta Aba Elástico Ofício Lombo 3 cm Top Line
Carpeta Ala Elástico Ofício Lomo 3 cm Top Line

 C.L.A. 335 x 30 x 235 mm  C 50 un. H 10 un. I 50 un. S 50 un.
 Espessura 0,7 mm

- Textura Line.
 - Mais resistente. Maior durabilidade
 - Terminação do elástico em plástico. Não oxida, não enferruja, não causa danos como corte e não passa oxidação para as folhas de papel.
- 



0236
Pasta Aba Elástico Ofício Lombo 4 cm Top Line
Carpeta Ala Elástico Ofício Lomo 4 cm Top Line

 C.L.A. 335 x 40 x 235 mm  C 50 un. H 50 un. I 50 un. Q 50 un. T 50 un. U 50 un. S 50 un.
 Espessura 0,75 mm

- Textura Line.
 - Mais resistente. Maior durabilidade
 - Terminação do elástico em plástico. Não oxida, não enferruja, não causa danos como corte e não passa oxidação para as folhas de papel.
- 



0237

Pasta Aba Elástico Ofício Lombo 5,5 cm Top Line

Carpeta Ala Elástico Ofício Lomo 5,5 cm Top Line

C.L.A. 335 x 55 x 235 mm C 50 un. H 50 un. I 50 un. S 50 un.

EspeSSura 0,8 mm



- Textura Line.
- Mais resistente. Maior durabilidade
- Terminação do elástico em plástico. Não oxida, não enferruja, não causa danos como corte e não passa oxidação para as folhas de papel.



0266

Pasta Aba Elástico A3 Top Line

Carpeta Ala Elástico A3 Top Line

C.L.A. 437 x 0 x 312 mm H 25 un.

EspeSSura 0,5 mm



- Textura Line.
- Mais resistente. Maior durabilidade
- Terminação do elástico em plástico. Não oxida, não enferruja, não causa danos como corte e não passa oxidação para as folhas de papel.



6053

Pasta Catálogo A4 PP Top Line c/ 20 Plásticos

Carpeta Catálogo A4 PP Top Line con 20 Plásticos

C.L.A. 310 x 20 x 237 mm H 20 un. I 20 un. S 20 un.



- Textura Line.
- Mais resistente. Maior durabilidade
- Sacos plásticos antiestáticos (gofrados), facilita a inserção das folhas.



6050

Pasta Catálogo A4 PP Top Line c/30 Plásticos

Carpeta Catálogo A4 PP Top Line con 30 Plásticos

C.L.A. 310 x 20 x 237 mm H 20 un. I 20 un. S 20 un.



- Textura Line.
- Mais resistente. Maior durabilidade
- Sacos plásticos antiestáticos (gofrados), facilita a inserção das folhas.



6054

Pasta Catálogo A4 PP Top Line c/40 Plásticos

Carpeta Catálogo A4 PP Top Line con 40 Plásticos

 C.L.A. 310 x 20 x 237 mm 

 Espessura 0,7 mm



- Mais resistente. Maior durabilidade
- Sacos plásticos antiestáticos (gofrados), facilita a inserção das folhas.



6093

Pasta Sanfonada Ofício Top Line c/ 12 Divisórias

Carpeta Acordeón Oficio Top Line con 12 Divisiones

 C.L.A. 382 x 35 x 263 mm 





- Mais resistente. Maior durabilidade
- Solda resistente. O miolo não solta.
- Terminação do elástico em plástico. Não oxida, não enferruja, não causa danos como corte e não passa oxidação para as folhas de papel.



6036

Pasta Catálogo A4 c/ 30 Plásticos

Carpeta Catálogo A4 con 30 Plásticos

 C.L.A. 310 x 20 x 240 mm 

 Espessura 0,7 mm



- Acabamento fosco soft touch.
- Mais resistente. Maior durabilidade
- Sacos plásticos antiestáticos (gofrados), facilita a inserção das folhas.





0450

Pasta Aba Elástico A4 Line

Carpeta Ala Elástico A4 Line

 C.L.A. 310 x 0 x 220 mm

 50 un.  50 un.  50 un.

 Espessura 0,35 mm



- Textura Line.
- Terminação do elástico em plástico. Não oxida, não enferruja, não causa danos como corte e não passa oxidação para as folhas de papel.



6037

Pasta Catálogo A4 Line c/ 10 Plásticos

Carpeta Catalogo A4 Line con 10 Plásticos

 C.L.A. 310 x 20 x 240 mm

 20 un.  20 un.  20 un.

 Espessura 0,35 mm



- Textura Line.
- Terminação do elástico em plástico. Não oxida, não enferruja, não causa danos como corte e não passa oxidação para as folhas de papel.



6038

Pasta Catálogo A4 Line c/ 30 Plásticos

Carpeta Catalogo A4 Line con 30 Plásticos

 C.L.A. 310 x 20 x 240 mm

 20 un.  20 un.  20 un.

 Espessura 0,35 mm



- Textura Line.
- Sacos plásticos antiestáticos (gofrados), facilita a inserção das folhas.



6039

Pasta Catálogo A4 Line c/ 50 Plásticos

Carpeta Catalogo A4 Line con 50 Plásticos

 C.L.A. 310 x 20 x 240 mm

 10 un.  10 un.  10 un.



 Espessura 0,35 mm



- Textura Line.
- Sacos plásticos antiestáticos (gofrados), facilita a inserção das folhas.



0252
Pasta Aba 1/2 Ofício Line
Carpeta Ala 1/2 Ofício Line



 C.L.A. 245 x 0 x 180 mm
 Espessura 0,3 mm

 50 un.	 50 un.	 50 un.
 50 un.	 50 un.	 50 un.
 50 un.	 50 un.	 50 un.

- Textura Line.
- Terminação do elástico em plástico. Não oxida, não enferruja, não causa danos como corte e não passa oxidação para as folhas de papel.



0253
Pasta Aba 1/2 Ofício Lombo 2,5 cm Line
Carpeta Ala 1/2 Ofício Lomo 2,5 cm Line



 C.L.A. 245 x 25 x 180 mm
 Espessura 0,4 mm

 50 un.	 50 un.
 50 un.	 50 un.

- Textura Line.
- Com porta canetas.
- Terminação do elástico em plástico. Não oxida, não enferruja, não causa danos como corte e não passa oxidação para as folhas de papel.



0254
Pasta Aba Elástico Ofício Line
Carpeta Ala Elástico Ofício Line



 C.L.A. 335 x 0 x 235 mm
 Espessura 0,33 mm





 50 un.	 50 un.	 50 un.
 50 un.	 50 un.	 50 un.
 50 un.	 50 un.	 50 un.
 100 un.		

- Textura Line.
- Terminação do elástico em plástico. Não oxida, não enferruja, não causa danos como corte e não passa oxidação para as folhas de papel.



0255
Pasta Aba Elástico Ofício Lombo 2 cm Line
Carpeta Ala Elástico Ofício Lomo 2 cm Line

 C.L.A. 335 x 20 x 235 mm
 Espessura 0,45 mm

 50 un.	 50 un.	 50 un.
 50 un.	 50 un.	 50 un.
 50 un.	 50 un.	 50 un.

- Textura Line.
- Terminação do elástico em plástico. Não oxida, não enferruja, não causa danos como corte e não passa oxidação para as folhas de papel.





0256

Pasta Aba Elástico Ofício Lombo 3 cm Line

Carpeta Ala Elástico Ofício Lomo 3 cm Line

 C.L.A. 335 x 30 x 235 mm

 C 50 un. H 50 un.
I 50 un. S 50 un.

 Espessura 0,45 mm



- Textura Line.
- Terminação do elástico em plástico. Não oxida, não enferruja, não causa danos como corte e não passa oxidação para as folhas de papel.



0257

Pasta Aba Elástico Ofício Lombo 4 cm Line

Carpeta Ala Elástico Ofício Lomo 4 cm Line

 C.L.A. 335 x 40 x 235 mm

 A 50 un. C 50 un. H 50 un.
I 50 un. Q 50 un. T 50 un.
U 50 un. S 50 un.

 Espessura 0,5 mm



- Textura Line.
- Terminação do elástico em plástico. Não oxida, não enferruja, não causa danos como corte e não passa oxidação para as folhas de papel.

ESCOLAR LINE



0258

Pasta Aba Elástico Ofício Lombo 5,5 cm Line

Carpeta Ala Elástico Ofício Lomo 5,5 cm Line

 C.L.A. 335 x 55 x 235 mm

 C 50 un. H 50 un.
I 50 un. S 50 un.

 Espessura 0,5 mm



- Textura Line.
- Terminação do elástico em plástico. Não oxida, não enferruja, não causa danos como corte e não passa oxidação para as folhas de papel.



6069

Pasta Sanfonada Porta Cheque PP Line c/ 12 Divisórias

Carpeta Acordeón Porta Cheque PP Line con 12 Divisiones

 C.L.A. 262 x 25 x 140 mm

 H 12 un. I 12 un. S 12 un.

 Espessura 0,55 mm





- Textura Line.
- Solda resistente. O miolo não solta.
- Terminação do elástico em plástico. Não oxida, não enferruja, não causa danos como corte e não passa oxidação para as folhas de papel.



6076

Pasta Sanfonada Porta Cheque PP Line c/31 Divisórias

Carpeta Acordeón Porta Cheque PP Line con 31 Divisiones

 C.L.A. 262 x 65 x 145 mm  12un.  12un.  12un.

 Espessura 0,6 mm



- Textura Line.
- Solda resistente. O miolo não solta.
- Terminação do elástico em plástico. Não oxida, não enferruja, não causa danos como corte e não passa oxidação para as folhas de papel.



6077

Pasta Sanfonada A4 PP Line c/31 Divisórias

Carpeta Acordeón A4 PP Line con 31 Divisiones

 C.L.A. 331 x 55 x 265 mm  6un.  6un.  6un.

 Espessura 0,6 mm





- Textura Line.
- Solda resistente. O miolo não solta.
- Terminação do elástico em plástico. Não oxida, não enferruja, não causa danos como corte e não passa oxidação para as folhas de papel.



6079

Pasta Sanfonada A4 PP Line c/ 12 Divisórias

Carpeta Acordeón A4 PP Line con 12 Divisiones

 C.L.A. 330 x 31 x 244 mm  12un.  12un.  12un.

 Espessura 0,55 mm







- Textura Line.
- Solda resistente. O miolo não solta.
- Terminação do elástico em plástico. Não oxida, não enferruja, não causa danos como corte e não passa oxidação para as folhas de papel.



0291 / 0297

Pasta Grampo DelloPlast c/ Grampo Plástico (Pacote c/ 10un.)

Carpeta Grapa DelloPlast con Grapa Plástica

 0291 - C.L.A. 340 x 0 x 245 mm  50un.  50un.  50un.

 Espessura 0,35 mm

0297 - A4  50un.

- Textura Line.
- Com grampo plástico instalado.
- Ideal para uso escolar.





0241

Pasta Aba Elástico Ofício DelloFine Carpeta Ala Elástico Ofício DelloFine

 C.L.A. 335 x 0 x 235 mm **C** 50 un. **H** 50 un. **P** 50 un.
Q 50 un. **R** 50 un. **T** 50 un.
U 50 un. **S** 50 un.

 Espessura 0,35 mm



- Textura Fine.
- Terminação do elástico em plástico. Não oxida, não enferruja, não causa danos como corte e não passa oxidação para as folhas de papel.



FINE

ESCOLAR



0242

Pasta Aba Elástico Ofício Lombo 2 cm DelloFine Carpeta Ala Elástico Ofício Lomo 2 cm DelloFine

 C.L.A. 335 x 20 x 235 mm **C** 50 un. **I** 50 un.

 Espessura 0,45 mm





- Textura Fine.
- Terminação do elástico em plástico. Não oxida, não enferruja, não causa danos como corte e não passa oxidação para as folhas de papel.



6070

Pasta Sanfonada A4 PP DelloFine c/12 Divisórias Carpeta Acordeón A4 PP DelloFine con 12Divisiones

 C.L.A. 330 x 32 x 236 mm **C** 12 un. **H** 12 un. **I** 12 un.

 Espessura 0,70 mm **P** 12 un. **Q** 12 un. **R** 12 un.
S 12 un.



- Botão resistente.
- Textura Fine.
- Solda resistente. O miolo não solta.
- Terminação do elástico em plástico. Não oxida, não enferruja, não causa danos como corte e não passa oxidação para as folhas de papel.



6072
Pasta Sanfonada A4 PP DelloFine c/31 Divisórias
Carpeta Acordeón A4 PP DelloFine con 31 Divisiones

C.L.A. 330 x 65 x 240 mm H 6un. I 6un.
 Espessura 0,9 mm

- Botão resistente.
- Textura Fine.
- Solda resistente. O miolo não solta.
- Terminação do elástico em plástico. Não oxida, não enferruja, não causa danos como corte e não passa oxidação para as folhas de papel.



2152
Maleta Ofício DelloFine
Maleta Oficio DelloFine

C.L.A. 360 x 43 x 260 mm
 Espessura 0,9 mm

- Textura Fine.
- Alça anatômica.
- Com porta canetas.
- Terminação do elástico em plástico. Não oxida, não enferruja, não causa danos como corte e não passa oxidação para as folhas de papel.

A 5un. C 5un. H 5un.
 I 5un. P 5un. Q 5un.
 T 5un. U 5un. S 5un.



2151
Maleta A3 DelloFine
Maleta A3 DelloFine

C.L.A. 505 x 32 x 353 mm
 Espessura 1 mm

- Textura Fine.
- Alça anatômica.
- Com porta canetas.
- Terminação do elástico em plástico. Não oxida, não enferruja, não causa danos como corte e não passa oxidação para as folhas de papel.

C 5un. H 5un. I 5un.
 P 5un. Q 5un. R 5un.
 S 5un.





2169

Caixa Organizadora Mini / Sapato

Caja Organizadora Mini / Sapato

📏 C.L.A. 288 x 178 x 123 mm

📏 Espessura 0,9 mm

📏 6,3 L

A 5un.
 C 5un.
 H 5un.
P 5un.
 Q 5un.
 T 5un.
U 5un.



- Textura Fine.
- Ótimo para guardar materiais escolares.



2174

Caixa Organizadora Padrão Camisa

Caja Organizadora Patrón Camisa

📏 C.L.A. 392 x 278 x 64 mm

📏 Espessura 0,9 mm

📏 7 L

A 5un.
 C 5un.
 H 5un.
P 5un.
 Q 5un.
 T 5un.
U 5un.



- Textura Fine.
- Ótimo para guardar papéis.



2170

Caixa Organizadora Pequena

Caja Organizadora Pequeña

📏 C.L.A. 318 x 260 x 185 mm

📏 Espessura 0,9 mm

📏 15,3 L

H 5un.
 P 5un.



- Textura Fine.
- Possui alça.

2171

Caixa Organizadora Média

Caja Organizadora Mediana

📏 C.L.A. 390 x 300 x 190 mm

📏 Espessura 0,9 mm

📏 22,2 L

H 5un.
 P 5un.



2172

Caixa Organizadora Grande

Caja Organizadora Grande

📏 C.L.A. 425 x 320 x 200 mm

📏 Espessura 1 mm

📏 27,2 L

H 5un.
 P 5un.













0961

Pasta Aba Elástico Ofício Lombo 2 cm PoliDello

Carpeta Ala Elástico Ofício Lomo 2 cm PoliDello

 C.L.A. 340 x 20 x 245 mm
  A 10 un.
  C 10 un.
  H 10 un.
  P 10 un.
  T 10 un.
  U 10 un.

 Gramatura 300 g/m²





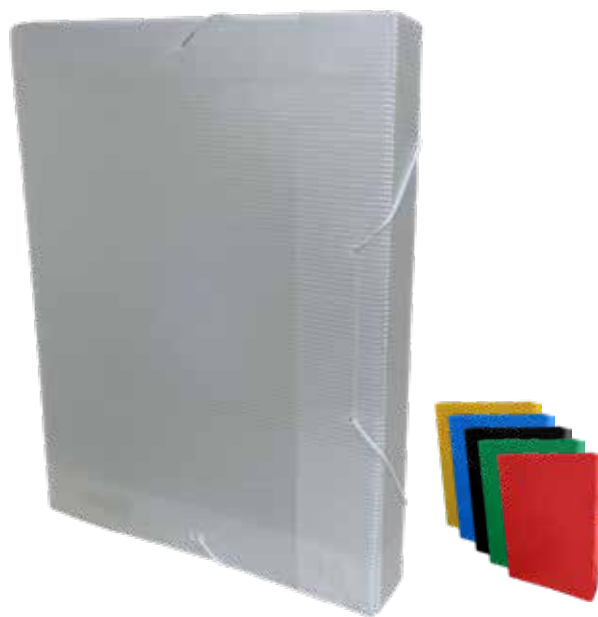



- Produzido em PP corrugado.
- Terminação do elástico em plástico. Não oxida, não enferruja, não causa danos como corte e não passa oxidação para as folhas de papel.



0962

Pasta Aba Elástico Ofício Lombo 3,5 cm PoliDello

Carpeta Ala Elástico Ofício Lomo 3,5 cm PoliDello

 C.L.A. 340 x 35 x 245 mm
  A 10 un.
  C 10 un.
  H 10 un.
  P 10 un.
  T 10 un.
  U 10 un.

 Gramatura 300 g/m²



- Produzido em PP corrugado.
- Terminação do elástico em plástico. Não oxida, não enferruja, não causa danos como corte e não passa oxidação para as folhas de papel.

LANÇAMENTO





3350

Caixa Organizadora PoliDello

Caja Organizadora PoliDello

 C.L.A. 460 x 320 x 250 mm
  C 5 un.
  G 5 un.
  P 5 un.

 Gramatura 450 g/m²

 37,50 L



- Produzido em PP corrugado.
- Ótimo para organização.
- Possui alças laterais.













0963

Pasta Aba Elástico Ofício Lombo 5,5 cm PoliDello

Carpeta Ala Elástico Ofício Lomo 5,5 cm PoliDello

 C.L.A. 340 x 55 x 245 mm
  10 un.
  10 un.
  10 un.
 10 un.
  10 un.
  10 un.

 Gramatura 300 g/m²









- Produzido em PP corrugado.
- Terminação do elástico em plástico. Não oxida, não enferruja, não causa danos como corte e não passa oxidação para as folhas de papel.



0970

Maleta Ofício PoliDello

Maleta Ofício PoliDello

 C.L.A. 385 x 45 x 285 mm
  5 un.
  5 un.
  5 un.
 5 un.
  5 un.

 Gramatura 300 g/m²









- Produzido em PP corrugado.
- Alça anatômica.
- Fechamento com trava.



0971

Maleta A3 PoliDello

Maleta A3 PoliDello

 C.L.A. 505 x 40 x 357 mm
  5 un.
  5 un.
  5 un.
 5 un.
  5 un.

 Gramatura 300 g/m²



- Produzido em PP corrugado.
- Alça anatômica.



0290

Pasta Grampo DelloPlus c/ Grampo Plástico

Carpeta Grapa DelloPlus con Grapa Plástica

 C.L.A. 343 x 0 x 236 mm

 Espessura 0,37 mm

A 50 un. **C** 50 un.
P 50 un. **T** 50 un.



- Com grampo plástico instalado.
- Papel cartão plastificado.
- Face interna branca



0292

Pasta Grampo Escolar DelloPlex c/ Grampo Plástico

Carpeta Grapa Escolar DelloPlex con Grapa Plástica

 C.L.A. 343 x 0 x 236 mm

 Espessura 0,35 mm

A 50 un. **C** 50 un. **E** 50 un.
P 50 un. **U** 50 un. **S** 50 un.



- Com grampo plástico instalado.
- Papel cartão plastificado.
- Face interna kraft



0199

Pasta Aba Elástico Escolar DelloPlex

Carpeta Ala Elástico Escolar DelloPlex

 C.L.A. 350 x 0 x 240 mm

 Espessura 0,32 mm

A 50 un. **C** 50 un. **E** 50 un.
P 50 un. **T** 50 un. **U** 50 un.
S 50 un.



- Papel cartão plastificado.
- Terminação do elástico em plástico. Não oxida, não enferruja, não causa danos como corte e não passa oxidação para as folhas de papel.





Solapa Individual 3100
H 96un.

Caixa Display 3109
H 100un.

Pct. c/ 10un. 3110
H 100un.

3100 / 3109 / 3110

Régua 30 cm DelloColor
Reglas 30 cm DelloColor

C.L.A. 310 x 34 x 3 mm



- Possui apoio para os dedos para maior firmeza e precisão.
- Ultrarresistente.



3111

Régua 30 cm Black White (Solapa Individual)
Reglas 30 cm Black White

C.L.A. 310 x 34 x 3 mm

E 96un. P 96un. S 96un.



- Possui apoio para os dedos para maior firmeza e precisão.
- Ultrarresistente.



Caixa Display 3114

Solapa Individual 3112

Serena

3112 / 3114

Régua 30 cm
Reglas 30 cm

C.L.A. 310 x 34 x 3 mm

- 3112 Serena - Solapa Individual
 AP 96un. BP 96un. LP 96un.
 VP 96un. WP 96un. SS 120un.
- 3114 Serena - Caixa Display
 SS 100un.
- 3112 - Solapa Individual
 W 96un. D 96un. SM 120un.



- Possui apoio para os dedos para maior firmeza e precisão.
- Ultrarresistente.



Solapa Individual 3115 / 3116

Full Color 3115

Aromas 3116

Caixa Display 3115

3115 / 3116

Régua 30 cm
Reglas 30 cm

C.L.A. 310 x 34 x 3 mm

- Solapa Individual - 3115
 C 96un. Q 96un.
 R 96un. VL 96un.
- Caixa Display
 SFL 100un.
- Solapa Individual - 3116
 01 96un. 02 96un.
 03 96un.



- Possui apoio para os dedos para maior firmeza e precisão.
- Full Color (3115) com cores vibrantes.
- Aromas (3116) com cores que compõe com o tema.
- Ultrarresistente.



Solapa Individual
8120





Pct. 10un.
8121



8120 / 8121

Esquadro 45° Potência
Cuadro 45° Potência

 C.L.A. 145 x 145 x 0 mm
 Espessura 2,8 mm

H 200un.



- Ultrarresistente.



Solapa Individual
8220





Pct. 10un.
8221



8220 / 8221

Esquadro 60° Potência
Cuadro 60° Potência

 C.L.A. 170 x 22 x 0 mm
 Espessura 2,8 mm

H 200un.



- Ultrarresistente.



Solapa Individual
8320





Pct. 10un.
8321



8320 / 8321

Transferidor 180° Potência
Transportador 180° Potência

 C.L.A. 144 x 81 x 0 mm
 Espessura 2,8 mm

H 200un.



- Ultrarresistente.

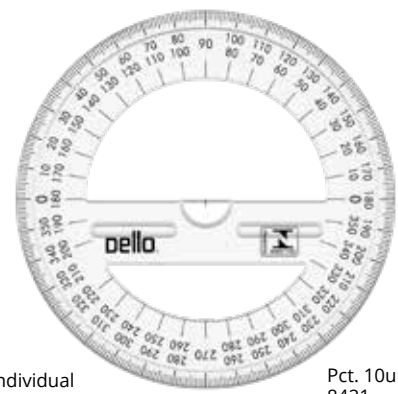

Solapa Individual
8420





Pct. 10un.
8421



8420 / 8421

Transferidor 360° Potência
Transportador 360° Potência

 C.L.A. 120 x 120 x 0 mm
 Espessura 2,8 mm



H 200un.

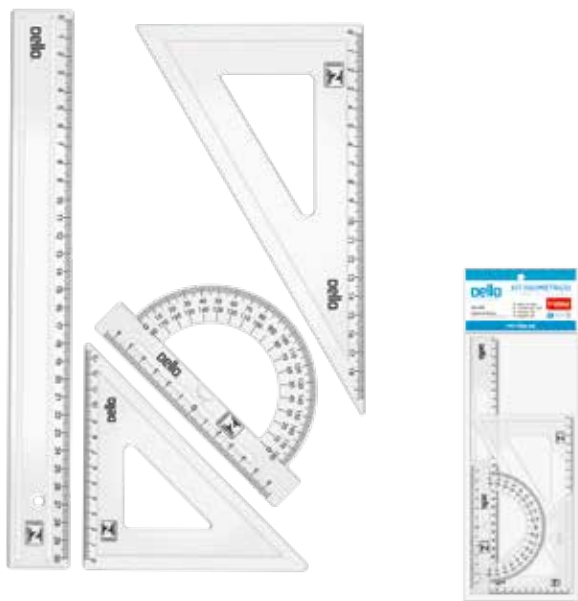

- Ultrarresistente.



8720
Kit Geométrico 1º Grau Potência
Set de Geometria 1º Grado Potência

 C.L.A. 315 x 160 x 0 mm
 Espessura 2,8 mm



H 100un.

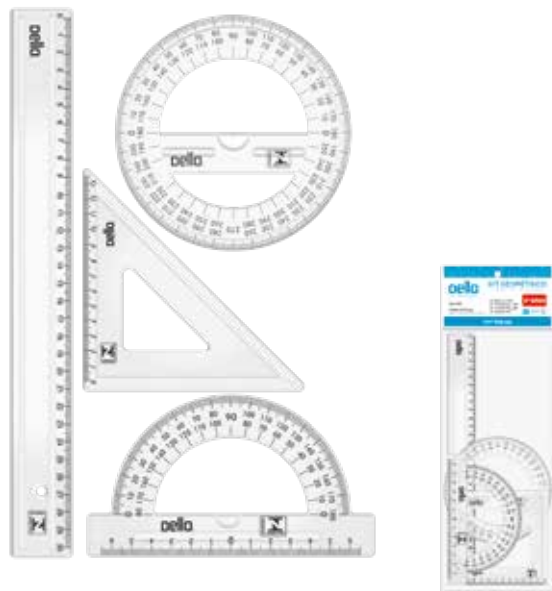

- Ultrarresistente.
- Contém Régua 30cm, Transferidor 180° e Esquadros 45° e 60°.



8721
Kit Geométrico 2º Grau Potência
Set de Geometria 2º Grado Potência

 C.L.A. 315 x 160 x 0 mm
 Espessura 2,8 mm

H 100un.



- Ultrarresistente.
- Contém Régua 30cm, Esquadro 60° e Transferidores 180° e 360°.

À Granel
 3104
 H 350un.



Pct. c/ 10un.
 3102
 H 120un.



Caixa
 Display
 3103
 H 120un.



Solapa
 Individual
 3101
 H 96un.



3101 / 3102 / 3103 / 3104
Régua 30 cm Potência
Reglas 30 cm Potência

 C.L.A. 310 x 35 x 0 mm
 Espessura 2,8 mm



- Ultrarresistente.
- Versão com caixa display, ótimo para o PDV.

RÉGUAS - POTÊNCIA

ESCOLAR



Pct. 20un.
8130
H 200un.



À granel
para licitações
8131
H 400un.



Caixa Display
8132
H 100un.

8130 / 8131 / 8132

Esquadro 45° Econômica

Cuadro 45° Econômica

 C.L.A. 145 x 145 x 0 mm

 Espessura 1,6 mm



- Ótimo custo-benefício.
- Versão com caixa display, ótimo para o PDV.



Pct. 20un.
8230
H 200un.



À granel
para licitações
8231
H 400un.





Caixa Display
8232
H 100un.

8230 / 8231 / 8232

Esquadro 60° Econômica

Cuadro 60° Econômica

 C.L.A. 170 x 22 x 0 mm

 Espessura 1,6 mm



- Ótimo custo-benefício.
- Versão com caixa display, ótimo para o PDV.

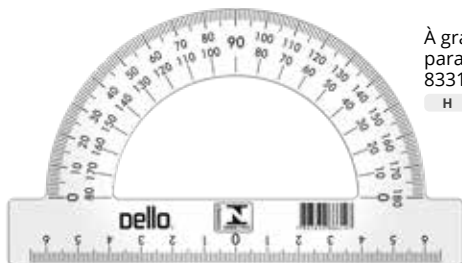

À granel
para licitações
8331
H 400un.

Pct. 20un.
8330
H 200un.



Caixa Display
8332
H 100un.

8330 / 8331 / 8332

Transferidor 180° Econômica

Transportador 180° Econômica

 C.L.A. 144 x 81 x 0 mm

 Espessura 1,6 mm



- Ótimo custo-benefício.
- Versão com caixa display, ótimo para o PDV.

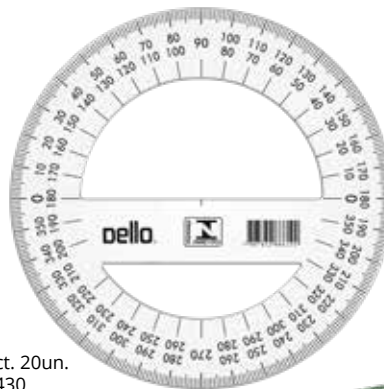

À granel
para licitações
8431
H 400un.

Pct. 20un.
8430
H 200un.





Caixa Display
8432
H 100un.

8430 / 8431 / 8432

Transferidor 360° Econômica

Transportador 360° Econômica

 C.L.A. 120 x 120 x 0 mm

 Espessura 1,6 mm



- Ótimo custo-benefício.
- Versão com caixa display, ótimo para o PDV.

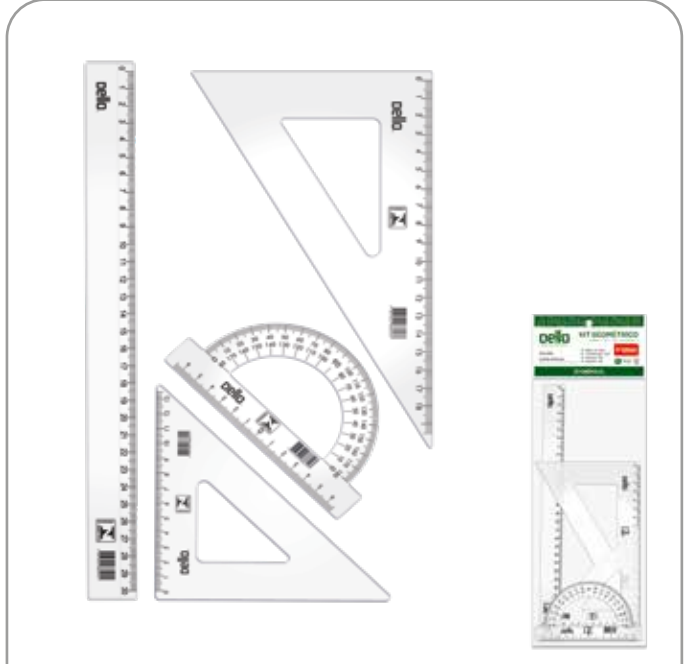

8730

Kit Geométrico 1º Grau Econômica Set de Geometria 1º Grado Econômica

- 📏 C.L.A. 315 x 160 x 0 mm
- ➦ Espessura 1,6 mm

H 200un.



- Ótimo custo-benefício.
- Contém Régua 30cm, Transferidor 180° e Esquadros de 60° e 45°.

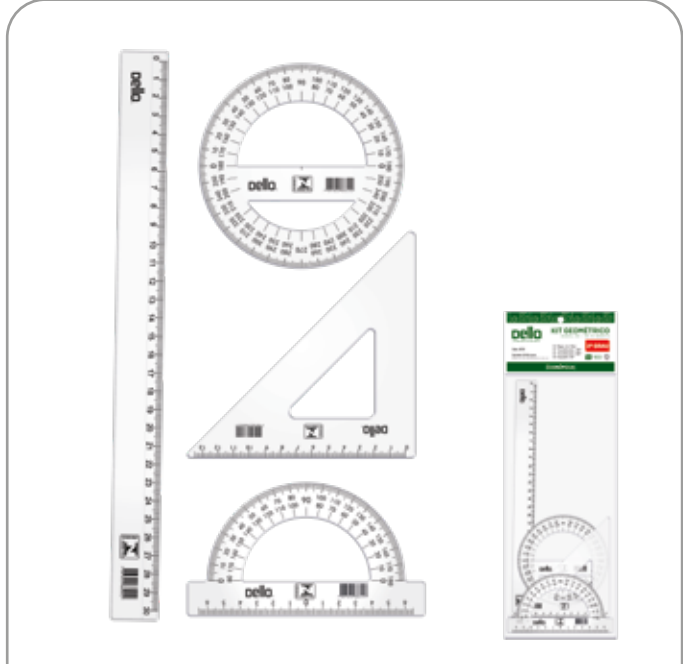

8731

Kit Geométrico 2º Grau Econômica Set de Geometria 2º Grado Econômica

- 📏 C.L.A. 315 x 160 x 0 mm
- ➦ Espessura 1,6 mm

H 200un.



- Ótimo custo-benefício.
- Contém Régua 30cm, Esquadro 60° e Transferidores 180° e 360°.

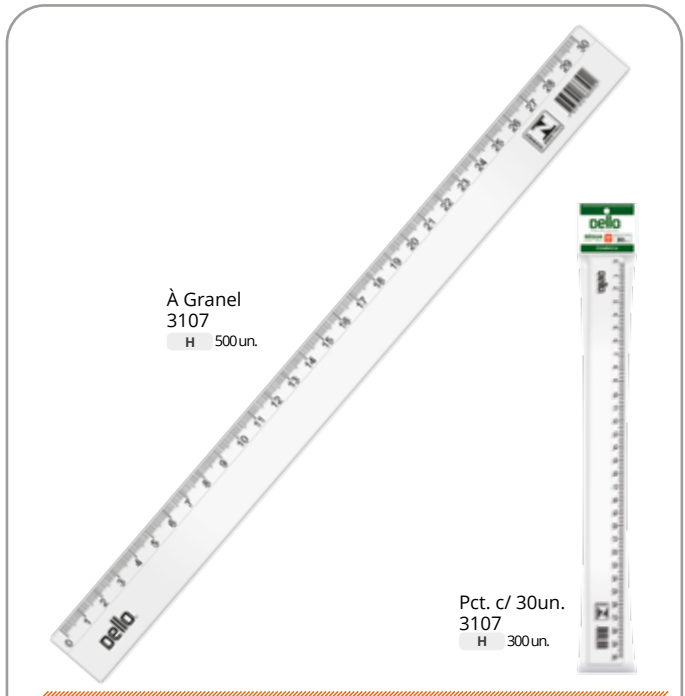

À Granel
3107
H 500un.

Pct. c/ 30un.
3107
H 300un.

3107

Régua 30 cm Econômica Reglas 30 cm Econômica

- 📏 C.L.A. 310 x 26 x 0 mm
- ➦ Espessura 1,6 mm



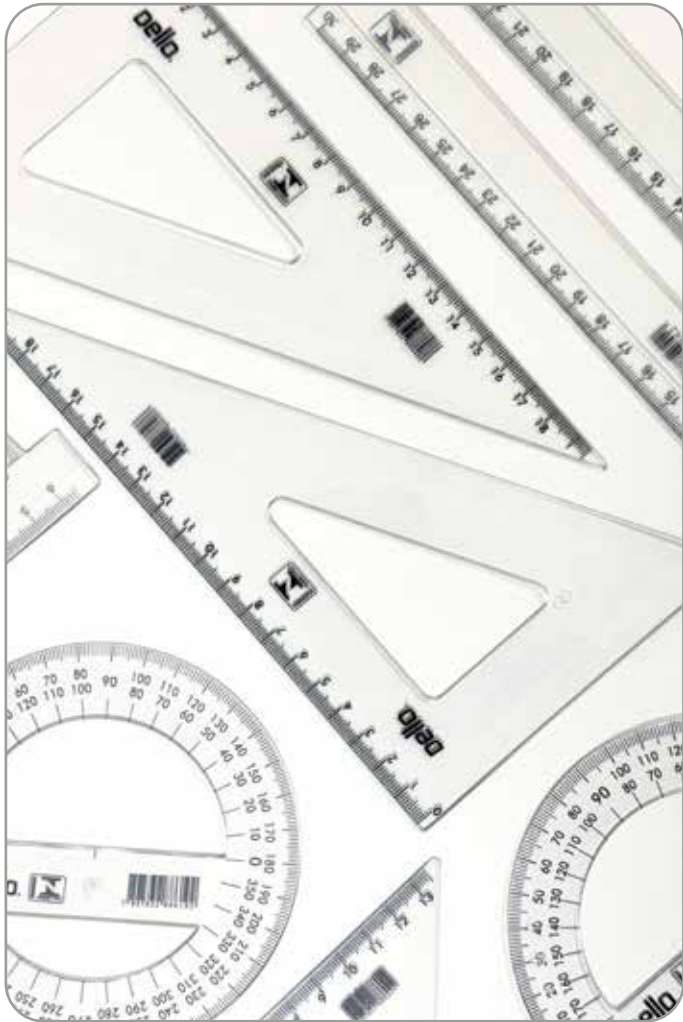

- Ótimo custo-benefício.





Cartucho
c/ 20un.

8610
Régua 15 cm Polipropileno Flexível
Regla 15 cm PP Flexible

 C.L.A. 310 x 0 x 16 mm
 Espessura 0,92 mm

H 200un.



- Produzido em PP Flexível. Não quebra.





Cartucho
c/ 20un.
8500
H 200un.



Cartucho
c/ 50un.
8510
H 300un.

8500 / 8510
Régua 30 cm Polipropileno Flexível
Regla 30 cm PP Flexible

 C.L.A. 310 x 0 x 32 mm
 Espessura 0,92 mm

- Produzido em PP Flexível. Não quebra.





Solapa Individual
8100
H 200un.



Caixa c/ 30un.
8110
H 300un.

8100 / 8110
Esquadro 21x45 Polipropileno Flexível
Cuadro 21x45 PP Flexible

 C.L.A. 141 x 0 x 141 mm
 Espessura 0,92 mm





- Produzido em PP Flexível. Não quebra.
- Versão com caixa display, ótimo para o PDV.



Caixa c/ 30un.
8210
H 300un.

Solapa Individual
8200
H 200un.

8200 / 8210
Esquadro 21x60 Polipropileno Flexível
Cuadro 21x60 PP Flexible

 C.L.A. 210 x 0 x 122 mm
 Espessura 0,92 mm



- Produzido em PP Flexível. Não quebra.
- Versão com caixa display, ótimo para o PDV.



Solapa Individual
8400
H 200un.

Caixa c/ 30un.
8410
H 300un.



8400 / 8410

Transferidor 360° Polipropileno Flexível

Transportador 360° PP Flexível

C.L.A. 122 x 0 x 122 mm

Espessura 0,92 mm



- Produzido em PP Flexível. Não quebra.
- Versão com caixa display, ótimo para o PDV.

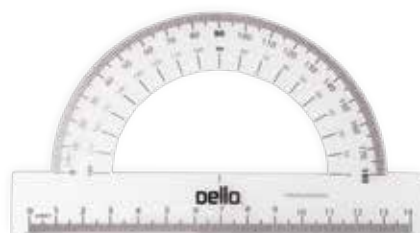

Solapa Individual
8300
H 200un.

Caixa c/ 30un.
8310
H 300un.



8300 / 8310

Transferidor 180° Polipropileno Flexível

Transportador 180° PP Flexível

C.L.A. 150 x 0 x 84 mm

Espessura 0,92 mm



- Produzido em PP Flexível. Não quebra.
- Versão com caixa display, ótimo para o PDV.

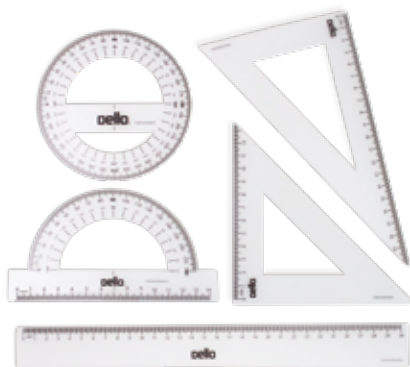

8700

Conjunto para Desenho Escolar Polipropileno Flexível

Conjunto para Diseño PP Flexível

C.L.A. 310 x 235 x 0 mm

H 50un.

Espessura 0,92 mm





- Produzido em PP Flexível. Não quebra.
- Contém Régua 30cm, Transferidores 180° e 360° e Esquadros 45° e 60°.





3013

Prancheta Ofício c/ Presilha de Pressão
Tabla Legajadora presión

 C.L.A. 255 x 160 x 40 mm  12 un.  12 un.

 Espessura 3 mm







- Possui régua na lateral.
- Presilha discreta com acabamento em plástico para não marcar a folha.



3014

Prancheta Ofício c/ Prendedor de Metal
Tabla Ofício c/ Gancho de Metal

 C.L.A. 255 x 160 x 40 mm  12 un.  12 un.

 Espessura 3 mm









- Possui régua na lateral.
- Prendedor em metal com mola mais forte.



3008 / 3009

Prancheta Meio Ofício
Tabla Meio Ofício

 C.L.A. 255 x 160 x 40 mm 3008  12 un.  12 un.  12 un.  12 un.

 Espessura 3 mm

3009 - Full Color  12 un.  12 un.  12 un.  12 un.  12 un.















- Prendedor em PS, não marca o papel.
- Régua na lateral e embaixo e transferidor de 90°.



3006 / 3007

Prancheta Ofício
Tabla Ofício

 C.L.A. 360 x 240 x 40 mm 3006  12 un.  12 un.  12 un.  12 un.  12 un.  12 un.  12 un.  12 un.  12 un.  12 un.

 Espessura 3 mm

3007 - Full Color  12 un.  12 un.  12 un.  12 un.  12 un.



- Prendedor em PS, não marca o papel.
- Régua na lateral e embaixo e transferidor de 90°.

CATÁLOGO 2025

OFFICE





0282
Pasta Aba Elástico 1/2 Ofício Executive
Carpeta Ala Elástico 1/2 Ofício Ejecutive

C.L.A. 245 x 0 x 180 mm P 50 un.
 Espessura 0,4 mm

- Textura de linho.
 - Acabamento premium.
 - Terminação do elástico em plástico. Não oxida, não enferruja, não causa danos como corte e não passa oxidação para as folhas de papel.
-



0267
Pasta Aba Elástico Ofício Executive
Carpeta Ala Elástico Ofício Ejecutive

C.L.A. 335 x 0 x 235 mm P 50 un. W 50 un. S 50 un.
 Espessura 0,5 mm

- Textura de linho.
 - Acabamento premium.
 - Terminação do elástico em plástico. Não oxida, não enferruja, não causa danos como corte e não passa oxidação para as folhas de papel.
-

71427321893

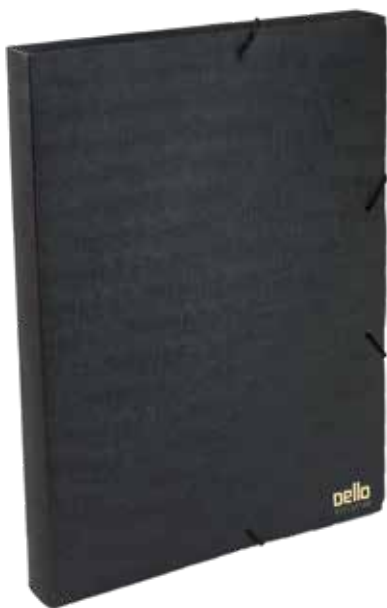

0268

Pasta Aba Elástico Ofício Lombo 2 cm Executive

Carpeta Ala Elástico Oficio Lomo 2 cm Ejecutive

 C.L.A. 335 x 20 x 235 mm

 50 un.

 Espessura 0,5 mm



- Textura de linho.
- Acabamento premium.
- Terminação do elástico em plástico. Não oxida, não enferruja, não causa danos como corte e não passa oxidação para as folhas de papel.

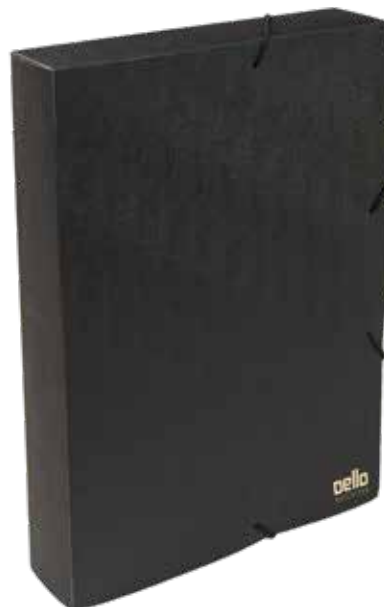

0269

Pasta Aba Elástico Ofício Lombo 4 cm Executive

Carpeta Ala Elástico Oficio Lomo 4 cm Ejecutive

 C.L.A. 335 x 40 x 235 mm

 50 un.

 Espessura 0,5 mm



- Textura de linho.
- Acabamento premium.
- Terminação do elástico em plástico. Não oxida, não enferruja, não causa danos como corte e não passa oxidação para as folhas de papel.



2166

Maleta Sanfonada Ofício Divisórias Executive

Maleta Acordeón Oficio Divisiones Executive

 C.L.A. 380 x 35 x 260 mm

 6 un.

 Espessura 0,7 mm



- Textura de linho.
- Acabamento premium.
- Com porta caneta.
- Alça anatômica
- Fechamento com trava.



2153

Maleta A2 Executive

Maleta A2 Executive

 C.L.A. 710 x 30 x 500 mm

 5 un.

 5 un.

 Espessura 1 mm



- Textura de linho.
- Acabamento premium.
- Com porta caneta.
- Alça anatômica.
- Terminação do elástico em plástico. Não oxida, não enferruja, não causa danos como corte e não passa oxidação para as folhas de papel.

EXECUTIVE

OFFICE

71427321893



6057

Pasta Catálogo A4 Executive c/ 10 Plásticos

Carpeta Catálogo A4 Executive con 10 Plásticos

 C.L.A. 310 x 20 x 240 mm

 20 un.

 Espessura 0,7 mm



- Textura de linho.
- Acabamento premium.
- Sacos plásticos antiestáticos (gofrados), facilita a inserção das folhas.



6056

Pasta Catálogo A4 Executive c/30 Plásticos

Carpeta Catálogo A4 Executive con 30 Plásticos

 C.L.A. 310 x 20 x 240 mm

 20 un.



- Textura de linho.
- Acabamento premium.
- Sacos plásticos antiestáticos (gofrados), facilita a inserção das folhas.

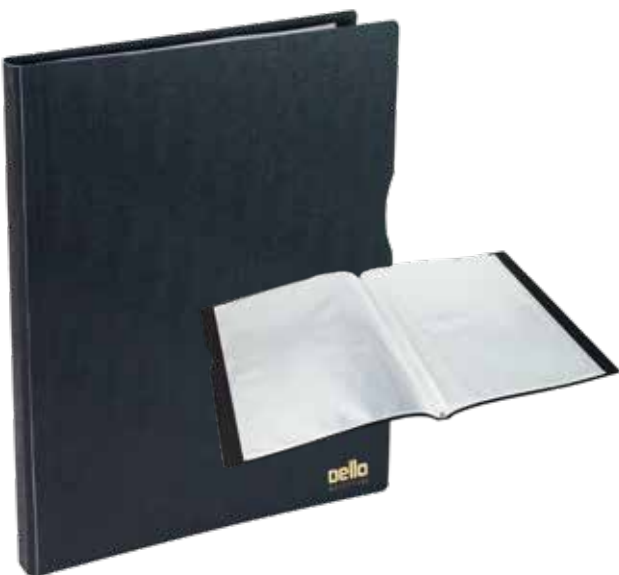

6058

Pasta Catálogo A4 Executive c/50 Plásticos

Carpeta Catálogo A4 Executive con 50 Plásticos

 C.L.A. 310 x 20 x 240 mm

 10 un.

 Espessura 0,7 mm



- Textura de linho.
- Acabamento premium.
- Sacos plásticos antiestáticos (gofrados), facilita a inserção das folhas.



6059

Pasta Catálogo A4 Executive c/ 100 Plásticos

Carpeta Catálogo A4 Executive con 100 Plásticos

 C.L.A. 310 x 32 x 233 mm

 10 un.

 Espessura 0,9 mm



- Textura de linho.
- Acabamento premium.
- Sacos plásticos antiestáticos (gofrados), facilita a inserção das folhas.



0294

Pasta Grampo Ofício Executive c/ Grampo Plástico (Pacote c/ 10un.)

Carpeta Grapa Ofício Executive con Grapa Plástica

 C.L.A. 335 x 0 x 245 mm

 P 50un.

 Espessura 0,55 mm



- Textura de linho.
- Acabamento premium.
- Com grampo plástico instalado.



8800

Estojo Multiuso Linho Executive

Estuche Multiuso Lino Executive

 C.L.A. 200 x 30 x 70 mm

 P 30un.

 Espessura 0,6 mm



- Textura de linho.
- Acabamento premium.

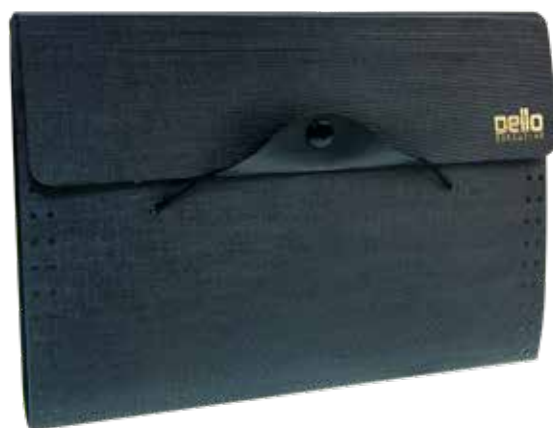

6081

Pasta Sanfônada Duplicata Executive c/ 12 Divisórias

Carpeta Acordeón Duplicata Executive con 12 Divisiones

 C.L.A. 250 x 31 x 182 mm

 P 12un.

 Espessura 0,7 mm



- Botão resistente.
- Textura de linho.
- Acabamento premium.
- Solda resistente. O miolo não solta.
- Terminação do elástico em plástico. Não oxida, não enferruja, não causa danos como corte e não passa oxidação para as folhas de papel.



6082

Pasta Sanfonada Duplicata Executive c/31 Divisórias

Carpeta Acordeón Duplicata Executive con 31 Divisiones

 C.L.A. 240 x 70 x 197 mm

 6 un.

 Espessura 0,8 mm

- Botão resistente.
- Textura de linho.
- Acabamento premium.
- Solda resistente. O miolo não solta.
- Terminação do elástico em plástico. Não oxida, não enferruja, não causa danos como corte e não passa oxidação para as folhas de papel.



6094

Pasta Sanfonada A4 Executive c/ 12 Divisórias

Carpeta Acordeón A4 Ejecutive con 12 Divisiones

 C.L.A. 331 x 32 x 244 mm

 12 un.  12 un.  12 un.

 12 un.



- Botão resistente.
- Textura de linho.
- Acabamento premium.
- Solda resistente. O miolo não solta.
- Terminação do elástico em plástico. Não oxida, não enferruja, não causa danos como corte e não passa oxidação para as folhas de papel.



0214

Pasta c/ Bolsa para Documentos Executive

Carpeta con Bolsa para Documentos Executive

 C.L.A. 220 x 0 x 310 mm

 30 un.



 Espessura 0,4 mm

- Textura de linho.
- Acabamento premium.
- Com porta cartão de visitas.





0270
Pasta L A4 DelloPlast
Carpeta L A4 DelloPlast

 C.L.A. 310 x 0 x 220 mm
 Espessura 0,15 mm



- | | | |
|---|---|---|
|  100 un. |  100 un. |  100 un. |
|  100 un. |  100 un. |  100 un. |
|  100 un. |  100 un. |  100 un. |
|  100 un. |  100 un. |  100 un. |









- Ótimo custo-benefício.
- Solda resistente. Não solta.



0271
Pasta L Ofício DelloPlast
Carpeta L Ofício DelloPlast

 C.L.A. 335 x 0 x 225 mm
 Espessura 0,15 mm



- | | | |
|---|---|---|
|  100 un. |  100 un. |  100 un. |
|  100 un. |  100 un. |  100 un. |
|  100 un. | | |



- Ótimo custo-benefício.
- Solda resistente. Não solta.



0935
Pasta Canaleta A4 DelloPlast
Carpeta con Vaina A4 DelloPlast

 C.L.A. 307 x 0 x 220 mm
 Espessura 0,15 mm



- | | |
|--|--|
|  50 un. |  50 un. |
|--|--|



- Ótimo custo-benefício.



0013
Envelope c/ Botão A4
Sobre con Botón A4

 C.L.A. 330 x 0 x 240 mm
 Espessura 0,2 mm

- | | |
|--|--|
|  30 un. |  30 un. |
|--|--|



- Ótimo custo-benefício.
- Alta durabilidade.
- Botão resistente.



6551
Tapete Protetor de Piso
Alfombra Protectora de Piso

C.L.A. 1200 x 0 x 1000 mm
Espessura 0,9 mm

H 6un. P 6un.



- Possui camada de EVA na base, para não deslizar.
- Versão com caixa display, ótimo para o PDV.



6553
Mouse Pad
Mouse Pad

C.L.A. 210 x 210 x 0 mm
Espessura 0,9 mm

P 30un.



- Textura de linho.
- Possui camada de EVA na base para não deslizar.



4151
Desk Pad
Desk Pad

C.L.A. 800 x 500 x 0 mm
Espessura 0,9 mm

P 20un.



- Textura de linho.
- Possui camada de EVA na base para não deslizar.



0326

Caixa Arquivo Morto PoliDello Ofício

Caja Archivo Muerto PoliDello Oficio

C.L.A. 350 x 135 x 250 mm A 25 un. C 25 un. E 25 un.
Espessura 2 mm G 25 un. P 25 un. T 25 un.
11,8 L U 25 un.

- Produzido em PP corrugado.
- Matéria-prima virgem.
- Estampado para uso em 3 posições diferentes.
- O primeiro com trava inteligente para não afundar a tampa.



0327

Caixa Arquivo Morto PoliDello Gigante

Caja Archivo Muerto PoliDello Gigante

C.L.A. 395 x 185 x 300 mm A 25 un. C 25 un. G 25 un.
21,9 L P 10 un. T 10 un. U 10 un.

- Produzido em PP corrugado.
- Matéria-prima virgem.
- Estampado para uso em 3 posições diferentes.
- O primeiro com trava inteligente para não afundar a tampa.



0306

Caixa para Arquivo Morto Ofício

Caja para Archivo Muerto Oficio

C.L.A. 365 x 143 x 256 mm X 25 un.

- Produzido em papel ondulado resistente.
- Estampado para uso em 3 posições diferentes.



0308

Caixa para Arquivo Morto Gigante

Caja para Archivo Muerto Gigante

C.L.A. 412 x 185 x 309 mm X 25 un.

- Produzido em papel ondulado resistente.
- Estampado para uso em 3 posições diferentes.





0539

Quadro de Avisos A5 Rígido

Cuadro de Avisos A5 Duro

C.L.A. 150 x 5 x 210 mm

H 12un.

Espessura 2 mm



- Curva A em vendas.
- Alta transparência.
- Acabamento premium com alta transparência.
- Possui face frontal e traseira, para proteger mais a folha.
- Acompanha fita dupla face.



0538

Quadro de Avisos A4 Rígido

Cuadro de Avisos A4 Duro

C.L.A. 300 x 5 x 210 mm

H 12un.

Espessura 2 mm



- Curva A em vendas.
- Alta transparência.
- Acabamento premium com alta transparência.
- Possui face frontal e traseira, para proteger mais a folha.
- Acompanha fita dupla face.



0535.PET

Quadro de Avisos A5 Cristal PET

Cuadro de Avisos A5

C.L.A. 210 x 5 x 150 mm

PET 12un.

Espessura 0,4 mm



- Produzido em PET ultratransparente.
- Dois em um. Serve para display de mesa ou quadro para parede.
- Acompanha base e fita dupla face.



0535
Quadro de Avisos A5
Quadro de Avisos A5

📏 C.L.A. 210 x 5 x 150 mm
➡ Espessura 0,4 mm

H 12un.



- Ótimo custo-benefício.
- Acompanha fita dupla face.



0534
Quadro de Avisos A4
Quadro de Avisos A4

📏 C.L.A. 300 x 5 x 210 mm
➡ Espessura 0,4 mm

H 12un.



- Ótimo custo-benefício.
- Acompanha fita dupla face.



0532
Quadro de Avisos Ofício
Quadro de Avisos Ofício

📏 C.L.A. 333 x 5 x 220 mm
➡ Espessura 0,4 mm

H 12un.



- Ótimo custo-benefício.
- Acompanha fita dupla face.



0533
Quadro de Avisos A3
Quadro de Avisos A3

📏 C.L.A. 420 x 5 x 300 mm
➡ Espessura 0,4 mm

H 12un.





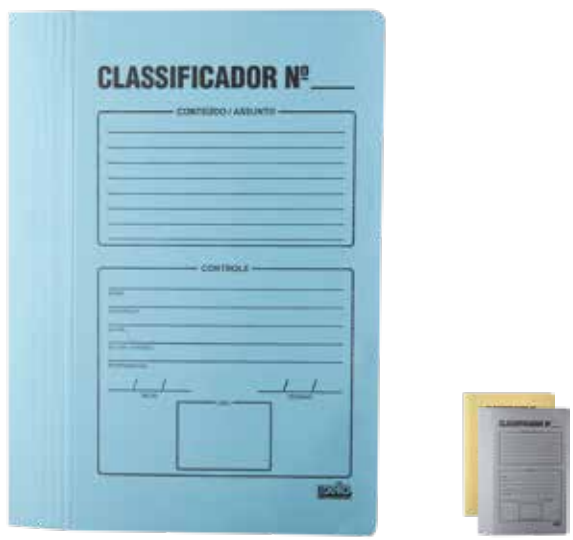

- Ótimo custo-benefício.
- Acompanha fita dupla face.



0203

Pasta Classificadora DelloClean c/ Impressão e Grampo Plástico 480g/m²
Carpeta Clasificadora DelloClean con Impresión y Grapa Plástica 480g/m²

 C.L.A. 345 x 0 x 235 mm  50 un.  50 un.  50 un.
 Gramatura 480 g/m²









- Ideal para arquivamento de papeis.
- Acompanha grampo plástico.



0204

Pasta Classificadora DelloClean c/ Grampo Plástico 480g/m²
Carpeta Clasificadora DelloClean con Grapa Plástica 480g/m²

 C.L.A. 345 x 1 x 235 mm  50 un.  50 un.  50 un.  50 un.
 Gramatura 480 g/m²









- Ideal para arquivamento de papeis.
- Acompanha grampo plástico.



0205

Pasta Classificadora DelloClean Plastificada c/ Grampo Plástico 480g/m²
Carpeta Clasificadora DelloClean Plastificada con Grapa Plástica 480g/m²

 C.L.A. 345 x 1 x 235 mm  50 un.  50 un.  50 un.  50 un.
 Gramatura 480 g/m²









- Ideal para arquivamento de papeis.
- Acompanha grampo plástico.



0209

Pasta Classificadora DelloClean 290g c/ Grampo Plástico
Carpeta Clasificadora DelloClean 290g con Grapa Plástica

 C.L.A. 345 x 0 x 235 mm  50 un.  50 un.  50 un.  50 un.
 Gramatura 290 g/m²



- Ideal para arquivamento de papeis.
- Acompanha grampo plástico.



0211

Pasta Classificadora DelloClean c/ Impressão 290g c/ Grampo Plástico

Carpeta Clasificadora DelloClean con Impresión 290g con Grapa Plástica

📏 C.L.A. 345 x 0 x 235 mm

🎨 A 50 un. C 50 un. G 50 un.
T 50 un.

📄 Gramatura 290 g/m²



- Ideal para arquivamento de papeis.
- Acompanha grampo plástico.



0712

Pasta Contrato DelloClean

Carpeta Contracto DelloClean

📏 C.L.A. 325 x 0 x 235 mm

🎨 C 50 un. E 50 un.

📄 Gramatura 180 g/m²



- Ideal para arquivamento de papeis.
- Acompanha grampo plástico.

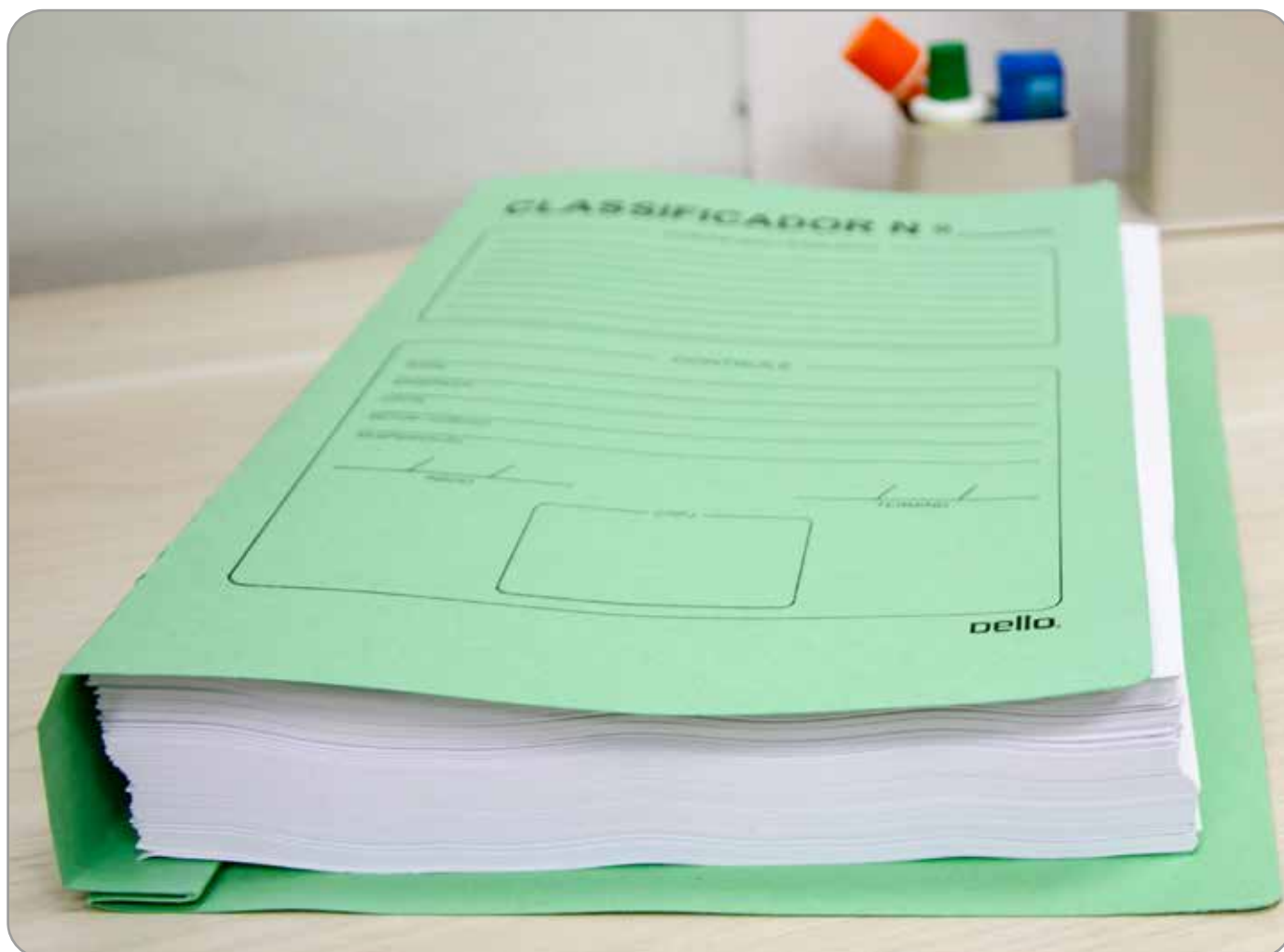





0705

Pasta Sanfonada DelloClassic Duplicata c/ 12 Divisórias Jan/Dez

Carpeta Acordeón DelloClassic Duplicata con 12 Divisiones Jan/Dez

 C.L.A. 250 x 25 x 180 mm 





- Produzido artesanalmente.
- Design clássico.



0701

Pasta Sanfonada DelloClassic Duplicata A/Z 1/31

Carpeta Acordeón DelloClassic Duplicata A/Z 1/31

 C.L.A. 250 x 65 x 190 mm 



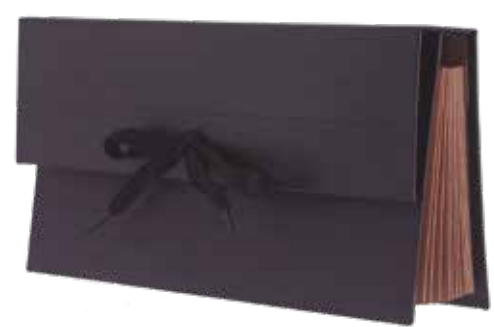

- Produzido artesanalmente.
- Design clássico.



0706

Pasta Sanfonada DelloClassic Porta Cheque c/ 12 Divisórias Jan/Dez

Carpeta Acordeón DelloClassic Porta Cheque con 12 Divisiones Jan/Dez

 C.L.A. 250 x 25 x 130 mm 





- Produzido artesanalmente.
- Design clássico.



0703

Pasta Sanfonada DelloClassic Porta Cheque A/Z 1/31

Carpeta Acordeón DelloClassic Porta Cheque A/Z 1/31

 C.L.A. 250 x 45 x 130 mm 



- Produzido artesanalmente.
- Design clássico.



0704

Pasta Sanfonada DelloClassic Ofício c/ 12 Divisórias Jan/Dez

Carpeta Acordeón DelloClassic Ofício con 12 Divisiones Jan/Dez

 C.L.A. 370 x 25 x 260 mm

 5 un.



- Produzido artesanalmente.
- Design clássico.



0700

Pasta Sanfonada DelloClassic Ofício A/Z 1/31

Carpeta Acordeón DelloClassic Ofício A/Z 1/31

 C.L.A. 370 x 45 x 260 mm

 5 un.



- Produzido artesanalmente.
- Design clássico.



DELLOCLASSIC

OFFICE



0005 Pasta Suspensa DelloPlast c/ Grampo Plástico

Carpeta Colgante DelloPlast con Grapa Plástica
C.L.A. 363 x 0,35 x 240 mm **C** 50 un. **H** 50 un. **I** 50 un.
Espessura 0.3 mm



- Haste plástica removível. Não quebra na posição correta.
- Ultrarresistente.



0006 Pasta Suspensa Executive c/ 12 Divisórias

Carpeta Colgante Executive con 12 Divisiones
C.L.A. 335 x 30 x 240 mm **PE** 6 un.
Espessura 0.4 mm



- Haste plástica removível. Não quebra na posição correta.
- Solda resistente. O miolo não solta.



0099 Pasta Suspensa DelloPlus c/ Grampo Plástico

Carpeta Colgante DelloPlus con Grapa Plástica
C.L.A. 361 x 0 x 240 mm **A** 48 un. **C** 48 un. **E** 48 un.
D 48 un. **P** 48 un. **T** 48 un.
Gramatura 250 g/m² **U** 48 un.



- Haste plástica removível. Não quebra na posição correta.
- Produzido em catão plastificado.
- 8 posições para grampo.
- Suporta até 300 folhas.
- Acompanha visor e etiqueta para identificação.







0001

Pasta Suspensa DelloKraft Plástica Haste Plástica c/ Grampo Plástico 170g/m²

Carpeta Colgante DelloKraft Plástica Varilla Plástica con Grapa Plástica

 C.L.A. 361 x 0 x 240 mm

 50 un.

 Gramatura 170 g/m²



- Haste plástica removível. Não quebra na posição correta.
- 8 posições para grampo.
- Suporta até 300 folhas.
- Acompanha visor e etiqueta para identificação.



0002.E
Versão em
embalagem
especial,
IDEAL PARA PDV

0002

Pasta Suspensa DelloKraft Haste Plástica c/ Grampo Plástico

Carpeta Colgante DelloKraft Varilla Plástica con Grapa Plástica

 C.L.A. 361 x 0 x 240 mm

0002

 50 un.

 Gramatura 170 g/m²

0002.E

 50 un.



- O mais vendido.
- Haste plástica removível. Não quebra na posição correta.
- 8 posições para grampo.
- Suporta até 300 folhas.
- Acompanha visor e etiqueta para identificação.



0004

Pasta Suspensa DelloKraft Arame e Ponteira c/ Grampo Plástico

Carpeta Colgante DelloKraft Varilla Metalica con Grapa Plástica

 C.L.A. 261 x 0 x 240 mm

 50 un.

 Gramatura 170 g/m²



- Haste plástica removível. Não quebra na posição correta.
- 8 posições para grampo.
- Suporta até 300 folhas.
- Acompanha visor e etiqueta para identificação.



0010

Pasta Suspensa DelloKraftSuper c/ 12 Divisórias

Carpeta Colgante DelloKraftSuper con 12 Divisiones

 C.L.A. 363 x 263 x 15 mm

 6 un.

 Gramatura 300 g/m²



- Haste plástica removível. Não quebra na posição correta.
- 8 posições para grampo.
- Acompanha visor e etiqueta para identificação.



0020

Pasta Suspensa DelloKraftSuper Haste Plástica c/ Grampo Plástico

Carpeta Colgante DelloKraftSuper Varilla Plástica con Grapa Plástica

 C.L.A. 361 x 0 x 240 mm

 50 un.

 Gramatura 300 g/m²



- Haste plástica removível. Não quebra na posição correta.
- 8 posições para grampo.
- Suporta até 300 folhas.
- Acompanha visor e etiqueta para identificação.



0022

Pasta Suspensa DelloKraftSuper Arame e Ponteira c/ Grampo Plástico

Carpeta Colgante DelloKraftSuper con Grapa Plástica

 C.L.A. 361 x 0 x 240 mm

 50 un.

 Gramatura 300 g/m²



- 8 posições para grampo.
- Suporta até 300 folhas.
- Acompanha visor e etiqueta para identificação.



0038

Pasta Suspensa MarmoDello Haste Plástica c/ Grampo Plástico

Carpeta Colgante MarmoDello Varilla Plástica con Grapa Plástica

 C.L.A. 361x0,31x240 mm

 50 un.

 Gramatura 305 g/m²



- Haste plástica removível. Não quebra na posição correta.
- 8 posições para grampo.
- Suporta até 300 folhas.
- Acompanha visor e etiqueta para identificação.



0039

Pasta Suspensa MarmoDello Plastificada Haste Plástica c/ Grampo Plástico

Carpeta Colgante MarmoDello Plastificada Varilla Plástica con Grapa Plástica

 C.L.A. 361x0,31x240 mm

 50 un.  50 un.

 Gramatura 305 g/m²



- Haste plástica removível. Não quebra na posição correta.
- 8 posições para grampo.
- Suporta até 300 folhas.
- Acompanha visor e etiqueta para identificação.



0040

Pasta Suspensa MarmoDello Plastificada Arame e Ponteira c/ Grampo Plástico

Carpeta Colgante Marmolada Pintada con Grapa Plástica

 C.L.A. 361x0,38x240 mm

 50 un.

 Gramatura 230 g/m²



- 8 posições para grampo.
- Suporta até 300 folhas.
- Acompanha visor e etiqueta para identificação.



0041

Pasta Suspensa Marmorizada Pintada Plastificada c/ Grampo Plástico

Carpeta Colgante Marmolada Pintada Plastificada con Grapa Plástica

 C.L.A. 361 x 0 x 240 mm

 50 un.

 Gramatura 230 g/m²



- 8 posições para grampo.
- Suporta até 300 folhas.
- Acompanha visor e etiqueta para identificação.



0044

Pasta Suspensa Marmorizada Pintada c/ Grampo Plástico

Carpeta Colgante Marmolada Pintada con Grapa Plástica

 C.L.A. 361x0,38x240 mm

 50 un.

 Gramatura 230 g/m²



- Haste plástica removível. Não quebra na posição correta.
- 8 posições para grampo.
- Suporta até 300 folhas.
- Acompanha visor e etiqueta para identificação.



0045

Pasta Suspensa Marmorizada Pintada Plastificada c/ Grampo Plástico

Carpeta Colgante Marmolada Pintada Plastificada con Grapa Plástica

 C.L.A. 361 x 0 x 240 mm

 50 un.

 Gramatura 230 g/m²



- Haste plástica removível. Não quebra na posição correta.
- 8 posições para grampo.
- Suporta até 300 folhas.
- Acompanha visor e etiqueta para identificação.



0711

Pasta Intercaladora DelloTim c/ Grampo Plástico

Carpeta Intercaladora DelloTim con Grapa Plástica

 C.L.A. 332 x 0 x 240 mm

 50un.

 Gramatura 420 g/m²



- Ideal para separação de folhas dentro da pasta suspensa.
- Acompanha grampo plástico.



0598

Pasta Vetro Lateral 6001 DelloKraftSuper c/ Grampo Plástico

Carpeta Vetrolateral 6001 DelloKraftSuper con Grapa Plástica

 C.L.A. 342 x 0 x 265 mm

 50un.

 Gramatura 300 g/m²



- Especial para arquivos próprios para estes formato.



0599

Pasta Vetro Lateral 8001 DelloKraftSuper c/ Grampo Plástico

Carpeta Vetrolateral 8001 DelloKraftSuper con Grapa Plástica

 C.L.A. 365 x 0 x 258 mm

 50un.

 Gramatura 300 g/m²



- Especial para arquivos próprios para estes formato.



0599.PL

Pasta Vetro Lateral 8001 DelloKraftSuper Plastificada c/ Grampo Plástico

Carpeta Vetrolateral 8001 DelloKraftSuper Plastificada con Grapa Plástica

 C.L.A. 365 x 0 x 258 mm

 50un.

 Gramatura 300 g/m²



- Especial para arquivos próprios para estes formato.



Solapa
c/ 25 un.



Caixa
c/ 50 un.

0116

Visor e Etiqueta Dello
Visor y Etiqueta Dello



—||— Espessura 0,15 mm

Caixa c/ 50 un.

E 20un.

Solapa c/ 25 un.

E 40un.



- Visor flexível produzido em PP.
- Etiqueta destacável em offset branco.



Solapa
c/ 50 un.

0302

Grampo U DelloFix
Grapa U DelloFix



C.L.A. 130 x 40 x 100 mm

—||— Espessura 2 mm

B 10un.



- Resistente.
- Ótimo custo-benefício.
- Perfeito para arquivar papéis em arquivo morto.



Caixa
c/ 50 un.

0300

Grampo Trilho DelloFix Cx. c/ 50un.
Grapa Trilho DelloFix Cx. con 50un.



C.L.A. 140 x 20 x 70 mm

—||— Espessura 0,21 mm

B 20un.



- Resistente.
- Acompanha padrão de furação do mercado.



0299
Grampo
Estendido
Solapa
c/ 50 un.

0301
Solapa
c/ 50 un.

0299 / 0301

Grampo Plástico DelloFix
Grapa Plástica Estendido DelloFix Amable



0299 - C.L.A. 300 x 9 x 112 mm



0301 - C.L.A. 205 x 153 x 25 mm

0299
 E 10un.

0301

E 20un. P 20un.



- Maleável, não quebra.
- Acompanha padrão de furação do mercado.



2160

Maleta Slim Line c/ 06 Pastas Suspensas DelloKraft

Maleta Slime Line con 06 Carpetas Colgantes DelloKraft

 C.L.A. 390 x 90 x 260 mm

 5un.  5un.

 Espessura 0,85 mm

- Alça anatômica.
- Fechamento com trava.
- Acompanha visor e etiqueta.





0318

Maleta DelloPlast s/ Pastas Suspensas

Maleta DelloPlast s/ Carpetas Colgantes

 C.L.A. 390 x 140 x 262 mm

 5un.  5un.

 Espessura 0,9 mm

 14,1 L

- Alça anatômica.
- Fechamento com trava.



0317

Maleta DelloPlast Montada c/ 10 Pastas Suspensas

Maleta DelloPlast Montada con 10 Carpetas Colgantes

 C.L.A. 390 x 140 x 260 mm

 Espessura 0,9 mm



- Alça anatômica.
- Fechamento com trava.
- Acompanha visor e etiqueta.



0317

 5 un. c/ Pastas Brancas
 5 un. c/ Pastas Pretas

0317.X

 5 un. c/ Pastas Kraft
 5 un. c/ Pastas Kraft





0319

Maleta DelloPlast Montada c/ 10 Pastas Suspensas Coloridas

Maleta DelloPlast Montada con 10 Carpetas Colgantes Color

 C.L.A. 390 x 140 x 260 mm

 5un.  5un.

 Espessura 0,9 mm

- Alça anatômica.
- Fechamento com trava.
- Acompanha visor e etiqueta.





0331

Maleta Organizadora Empilhável

Maleta Organizadora Apilable

 C.L.A. 460 x 210 x 270 mm **C** 3un. **H** 3un. **P** 3un.

 26 L



- Alça anatômica.
- Fechamento com trava.
- Injetado em PP



0332

Maleta Arquivo Empilhável c/ 6 Pastas Suspensas Kraft

Maleta Archivo Apilable con 6 Carpetas Colgantes Kraft

 C.L.A. 460 x 210 x 270 mm **H** 3un. **P** 3un.



- Alça anatômica.
- Fechamento com trava.
- Injetado em PP
- Acompanha visor e etiqueta.

0320
Com Pastas
Suspensas
Brancas

0321
Com Pastas
Suspensas
Coloridas

0322
Com Pastas
Suspensas
Kraft



0320 / 0321 / 0322

Organizador DelloColor c/ 06 Pastas Suspensas

Organizador DelloColor con 06 Carpetas Colgantes

 C.L.A. 425 x 145 x 270 mm

H 3un.



- Produto injetado em PS.
- Acompanha visor e etiqueta.
- Acompanha tag para lateral.

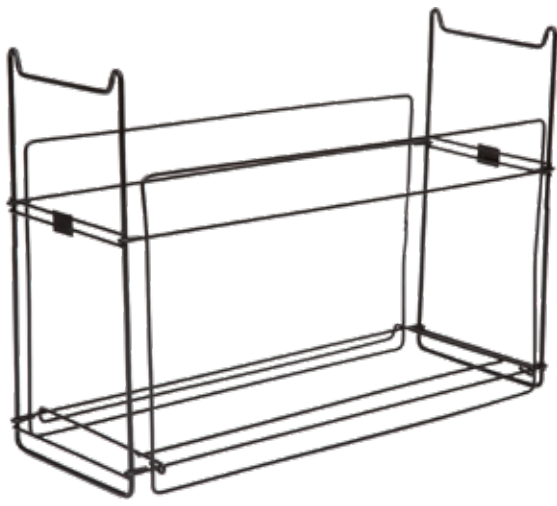

0314

Kit Aramado Dellos/ Pastas Suspensas
Kit Alambrado Dello s/ Carpetas Colgantes

C.L.A. 400 x 140 x 280 mm

10 un.



- Design leve, ideal para ficar à mostra.

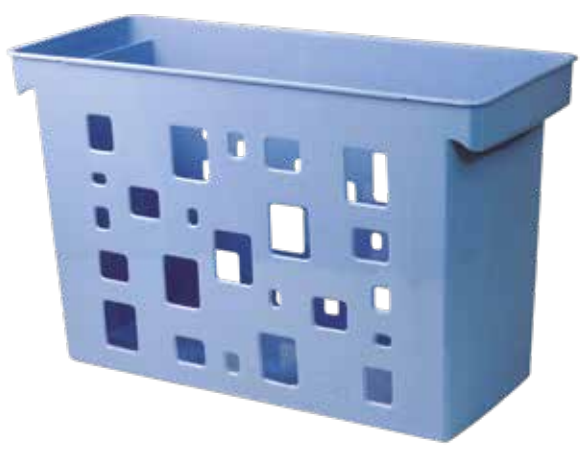

0329

Caixa Arquivo Multiuso s/ Pasta Suspensa
Caja Archivo Multiuso s/ Carpeta Colgante

C.L.A. 440 x 175 x 270 mm

20,7 L

5 un. 5 un.

5 un. 5 un.



- Possui pegadores laterais.
- Pode ser utilizado para pastas suspensas.



0328

Caixa Arquivo DelloColor c/ 6 Pastas Suspensas Coloridas

Caja Archivo DelloColor con 6 Carpetas Colgantes Color

C.L.A. 440 x 175 x 270 mm

5 un.



- Possui pegadores laterais.
- Acompanha visor e etiqueta.



0330

Caixa Arquivo DelloColor c/6 Pastas Suspensas Kraft

Caja Archivo DelloColor con 6 Carpetas Colgantes Kraft

C.L.A. 440 x 175 x 270 mm

5 un.



- Possui pegadores laterais.
- Acompanha visor e etiqueta.

71427321893



3030
Porta Canetas Duplo
Porta Boligrafos Duplo

C.L.A. 170 x 70 x 80 mm
 Espessura 2,55 mm

B 12un. **H** 12un. **I** 12un.
D 12un. **P** 12un. **RG** 12un.
W 12un. **SM** 12un. **S** 12un.



- Ultrarresistente.
- Molde único, o fundo não sai.

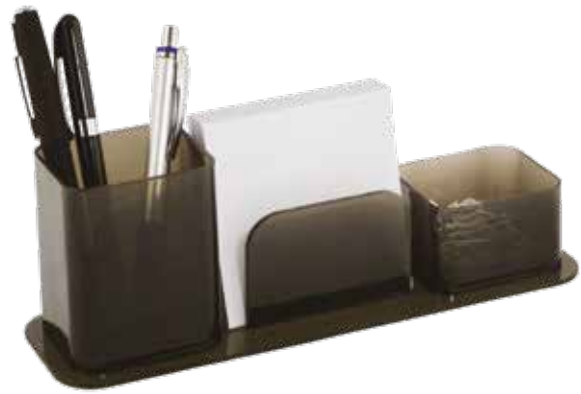

3031
Porta Canetas Triplo
Porta Boligrafos Triple

C.L.A. 240 x 70 x 80 mm
 Espessura 2,55 mm

B 12un. **H** 12un. **I** 12un.
P 12un. **W** 12un. **S** 12un.



- Ultrarresistente.
- Molde único, o fundo não sai.



3034
Porta Lápis, Clips e Lembrete
Porta Lapís, clips y membetes

C.L.A. 230 x 66 x 90 mm
 Espessura 2,5 mm

H 12un. **I** 12un.



- Ultrarresistente.
- Molde único, o fundo não sai.



3005
Porta Canetas DelloColor
Porta Boligrafos DelloColor

C.L.A. 135 x 120 x 90 mm

H 12un. **I** 12un. **D** 12un.
RG 12un. **S** 12un.



- Ultrarresistente.
- Molde único, o fundo não sai.

71427321893



1º LUGAR

3029
Porta Objetos DelloColor
Porta Objetos DelloColor

C.L.A. 80 x 77 x 97 mm
 Espessura 2,1 mm

- | | | |
|---------|----------|----------|
| B 12un. | BP 12un. | H 12un. |
| I 12un. | LP 12un. | D 12un. |
| P 12un. | W 12un. | WP 12un. |
| S 12un. | SM 12un. | |



- Ultrarresistente.
- Extremamente prático.



6413 / 6513
Kit c/ 3 Porta Objetos
Kit con 3 Porta Objetos

C.L.A. 80 x 77 x 210 mm

- | | | |
|--------------------------|--------|--------|
| H 8un. | E 8un. | P 8un. |
| W 8un. | | |
| 6513 - Full Color | | |
| C 8un. | Q 8un. | R 8un. |
| VL 8un. | | |



- Ultrarresistente.
- Extremamente prático.



6417
Kit c/ 2 Porta Objetos
Kit con 2 Porta Objetos

C.L.A. 82 x 77 x 125 mm

- | | | |
|---------|---------|---------|
| E 12un. | H 12un. | P 12un. |
|---------|---------|---------|



- Ultrarresistente.
- Extremamente prático.



3004
Organizador de Gavetas
Organizador de Cajones

C.L.A. 261 x 240 x 23 mm

- | | |
|---------|---------|
| H 12un. | P 12un. |
|---------|---------|



- Ideal para não deixar o material solto na gaveta.

71427321893









ORGANIZAÇÃO OFFICE

OFFICE

6023
Organizador de Objetos DelloColor

Organizador de Objetos DelloColor

 C.L.A. 245 x 87 x 280 mm

 B	6un.	 H	6un.	 I	6un.
 P	6un.	 W	6un.		

 Espessura 3 mm









- Ultrarresistente, paredes espessas.
- Multiuso, um dos produtos mais versáteis. Serve para office e home.
- Ótimo como porta revistas.



5022
Pasta Fichário Injetado c/ 4 Argolas

Carpeta 4 Anillos

 C.L.A. 270 x 45 x 315 mm

 BP	6un.	 H	6un.	 LP	6un.
 P	6un.	 WP	6un.		





- Capa resistente.
- Possui elástico para fechamento.
- Acompanha estojo nas versões Serena.



2403
Cesto de Lixo 12,5 L

Barreiro 12,5 L

 C.L.A. 300 x 208 x 295 mm

 P	6un.
---	------



- Resistente, simples e prático.
- Necessário em todos os ambientes.

71427321893



3049

Caixa Correspondência Fixa Dupla (chilincado)

Caja Correspondencia Fija Doble

 C.L.A. 355 x 253 x 125 mm

 Espessura 2,15 mm

 5un.  5un.



- Ultrarresistente
- Ótimo para não deixar papéis soltos em cima da mesa.
- Os papéis podem ser setorizados.





3050

Caixa Correspondência Fixa Tripla (chilincado)

Caja Correspondencia Fija Triple

 C.L.A. 355 x 253 x 185 mm

 3un.  3un.



- Ultrarresistente
- Ótimo para não deixar papéis soltos em cima da mesa.
- Os papéis podem ser setorizados.





3043

Caixa Correspondência Articulável Dupla

Caja Correspondencia Articulable Doble

 C.L.A. 355 x 250 x 90 mm

 Espessura 2,15 mm

Chilincado
 6un.  6un.  6un.
 6un.  6un.  6un.

Caixa
 6un.  6un.



- Ultrarresistente
- Ótimo para não deixar papéis soltos em cima da mesa.
- Os papéis podem ser setorizados.

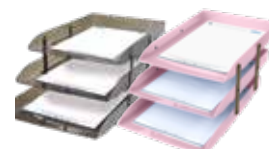





3044

Caixa Correspondência Articulável Tripla

Caja Correspondencia Articulable Triple

 C.L.A. 355 x 253 x 125 mm

 Espessura 2,15 mm

Chilincado
 4un.  4un.
 4un.

Caixa
 4un.  4un.



- Ultrarresistente
- Ótimo para não deixar papéis soltos em cima da mesa.
- Os papéis podem ser setorizados.



3042
Caixa Correspondência Simples (chilincado)
Caja Correspondencia Simples (chilincado)

📏 C.L.A. 356 x 250 x 45 mm H 8un.



- Ultrarresistente
- Ótimo para não deixar papéis soltos em cima da mesa.



3053
Expositor Modular (Kit c/ 2 peças)
Expositor Modular (kit con 2 partes)

📏 C.L.A. 365 x 120 x 355 mm H 3un.



- Ultrarresistente
- Podem ser encaixadas várias peças.
- Possui alça para pendurar.



3054
Expositor
Exhibidor

📏 C.L.A. 235 x 40 x 295 mm
—+— Espessura 2,01 mm

Chilincado H 6un. I 6un.
Caixa H 6un. I 6un.



- Ultrarresistente
- Com pés removíveis.



3055
Organizador de Documentos Triplo DelloColor
Organizador de Documentos Triple DelloColor

📏 C.L.A. 328 x 120 x 300 mm H 3un. P 3un.
—+— Espessura 2,75 mm



- Ultrarresistente
- Acompanha parafusos para fixação na parede.

71427321893

71427321893



CATÁLOGO 2025

HOME





3071
Organizador de Cosméticos Compacto c/ 16 Divisórias
Organizador de Cosméticos Compacto con 16 Divisiones



 C.L.A. 112 x 112 x 75 mm  H 12un.



- Qualidade premium.
- Ultrarresistente.



3072
Organizador de Cosméticos Essencial c/ 11 Divisórias
Organizador de Cosméticos Essencial con 11 Divisiones



 C.L.A. 238 x 113 x 75 mm  H 6un.



- Qualidade premium.
- Ultrarresistente.



3073
Organizador de Cosméticos Plus c/31 Divisórias
Organizador de Cosméticos Plus con 31 Divisiones



 C.L.A. 238 x 238 x 75 mm  H 6un.



- Qualidade premium.
- Ultrarresistente.



3074
Organizador de Cosméticos Compacto c/6 Divisórias
Organizador de Cosméticos Compacto con 6 Divisiones

 C.L.A. 112 x 112 x 75 mm  H 12un.



- Qualidade premium.
- Ultrarresistente.



3075

Organizador c/ Tapa 3 Divisórias
Organizador con Tapa 3 Divisiones

C.L.A. 112 x 112 x 105 mm
 1,18 L

H 6un.



- Qualidade premium.
- Ultrarresistente.



Versão
Cristal
em PS

3080

Caixa Organizadora Mini c/ Tapa Soul
Caja Organizadora Mini con Tapa Soul

C.L.A. 126 x 126 x 55 mm H 12un. HG 12un. HG1 12un.
 HW2 12un. W2 12un.
 870 ml



- Muito prático.
- Ótimo para organizar armários e gavetas.
- Versão Cristal injetado em PS



Versão
Cristal
em PS

3081

Caixa Organizadora Pequena c/ Tapa Soul
Caja Organizadora Pequeña con Tapa Soul

C.L.A. 254 x 125 x 55 mm H 12un. HG 12un. HG1 12un.
 HW2 12un. W2 12un.
 1,7 L



- Muito prático.
- Ótimo para organizar armários e gavetas.
- Versão Cristal injetado em PS





3082

Caixa Organizadora Média c/ Tapa Soul

Caja Organizadora Mediana con Tapa Soul

 C.L.A. 280 x 280 x 125 mm

 6un.  6un.

 9,8 L



- Muito prático.
- Ótimo para organizar armários.
- Versão Cristal injetado em PS





3083

Caixa Organizadora Grande c/ Tapa Soul

Caja Organizadora Grande con Tapa Soul

 C.L.A. 424 x 300 x 185 mm

 5un.  5un.

 23,5 L



- Muito prático.
- Ótimo para organizar armários.



CÓSMÉTICOS / SOUL

HOME





Versão Cristal em PS

3090
Combo Soul + Compacto 2
 Combo Soul + Compacto 2

C.L.A. 125 x 125 x 125 mm H 6un. GG 6un. W2W2 6un.



- O queridinho das lojas de produtos para cuidados pessoais.
- Versão Cristal com as duas peças injetadas em PS



Versão Cristal em PS

3091
Combo Soul + Porta Algodão
 Combo Soul + Organizador com Tapa

C.L.A. 125 x 125 x 155 mm H 6un. HG 6un. W2W2 6un.



- O queridinho das lojas de produtos para cuidados pessoais.
- Versão Cristal com as duas peças injetadas em PS



Versão Cristal em PS

3092
Combo Soul + Essencial
 Combo Soul + Essencial

C.L.A. 255 x 125 x 126 mm H 6un. HG 6un. HLP 6un.



- O queridinho das lojas de produtos para cuidados pessoais.
- Versão Cristal com as duas peças injetadas em PS



3093
Combo Soul + Plus
 Combo Soul + Plus

C.L.A. 277 x 277 x 195 mm GG 4un. HG 4un. HLP 4un.



- O queridinho das lojas de produtos para cuidados pessoais.



2204



Caixa Organizadora Linho Pequena



Caja Organizadora Lino Pequeña

 C.L.A. 260 x 260 x 155 mm

 Espessura 0,9 mm

 10,4 L

 Sun.  Sun.  Sun.

 Sun.  Sun.



- Textura em linho.
- Produto prático e indispensável para organização.
- Possui alças laterais.

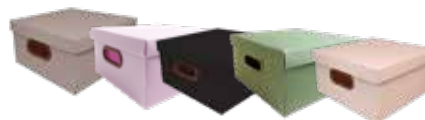

2205

Caixa Organizadora Linho Média

Caja Organizadora Lino Mediana

 C.L.A. 300 x 300 x 155 mm

 Espessura 0,9 mm

 13,9 L

 Sun.  Sun.  Sun.

 Sun.  Sun.  Sun.



- Textura em linho.
- Produto prático e indispensável para organização.
- Possui alças laterais.

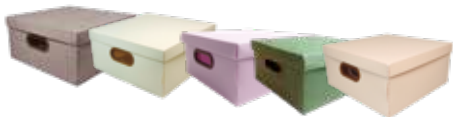



2206

Caixa Organizadora Linho Grande

Caja Organizadora Lino Grande

 C.L.A. 360 x 360 x 165 mm

 Espessura 0,9 mm

 21,3 L

 Sun.  Sun.  Sun.

 Sun.  Sun.  Sun.



- Textura em linho.
- Produto prático e indispensável para organização.
- Possui alças laterais.





2192



Caixa Organizadora Linho Média

Caja Organizadora Lino Mediana

 C.L.A. 390 x 300 x 195 mm

 Espessura 0,9 mm

 22,8 L

 Sun.  Sun.



- Textura em linho.
- Produto prático e indispensável para organização.
- Possui alças laterais.



2550
Caixa Organizadora Média Natalina
Caja Organizadora Mediana Navidad

C.L.A. 390 x 300 x 195 mm
 Espessura 0,9 mm
 22,8 L

Sun.



- Tampa espantapa com motivos natalinos.
- Base com textura em linho.
- Ideal para guardar os enfeites de Natal.
- Possui alças laterais.



2189
Caixa Organizadora Baixa Média
Caja Organizadora Baja Mediana

C.L.A. 390 x 300 x 110 mm
 Espessura 0,9 mm
 12,8 L

Sun.



- Textura em linho.
- Produto prático e indispensável para organização.



0335
Caixa Multiuso Larga
Caja Multiuso Ancha

C.L.A. 435 x 290 x 270 mm
 Espessura 0,859 mm
 33,67 L

Sun. Sun.



- Injetado em PP.
- Ótimo para organização em geral.



2197.08

Caixa Organizadora Média Folhagem

Caja Organizadora Mediana Hojas

 C.L.A. 395 x 300 x 195 mm

5un.

 Espessura 0,8 mm

 22,8 L



- Tampa espantapa para combinar com o ambiente.
- Base com textura em linho.
- Produto prático e indispensável para organização.
- Possui alças laterais.



2189.01

Caixa Organizadora Baixa Média Folhagem

Caja Organizadora Baja Mediana Hojas

 C.L.A. 390 x 300 x 110 mm

5un.

 Espessura 0,9 mm

 12,8 L



- Tampa espantapa para combinar com o ambiente.
- Base com textura em linho.
- Produto prático e indispensável para organização.
- Possui alças laterais.



2302

Organizador de Despensa Grande Branco

Organizador de Despensa Grande blanco

 C.L.A. 380 x 290 x 160 mm

 5un.

 Espessura 0,9 mm

 17,6 L



- Ótimo para a organização da despensa.
- Possui alças laterais.
- Possui canaletas para maior firmeza das laterais.





2193

Caixa Organizadora de Objetos c/6 un.

Caja Organizadora de Objetos con 6 un.

 C.L.A. 240 x 175 x 100 mm

 H 4un.  W 4un.

 Espessura 0,8 mm



- Ótimo para guardar miudezas.
- Produto com tampa.



2194

Caixa Organizadora de Objetos c/9 un.

Caja Organizadora de Objetos con 9 un.

 C.L.A. 260 x 240 x 100 mm

 H 4un.

 Espessura 0,8 mm



- Ótimo para guardar miudezas.
- Produto com tampa.

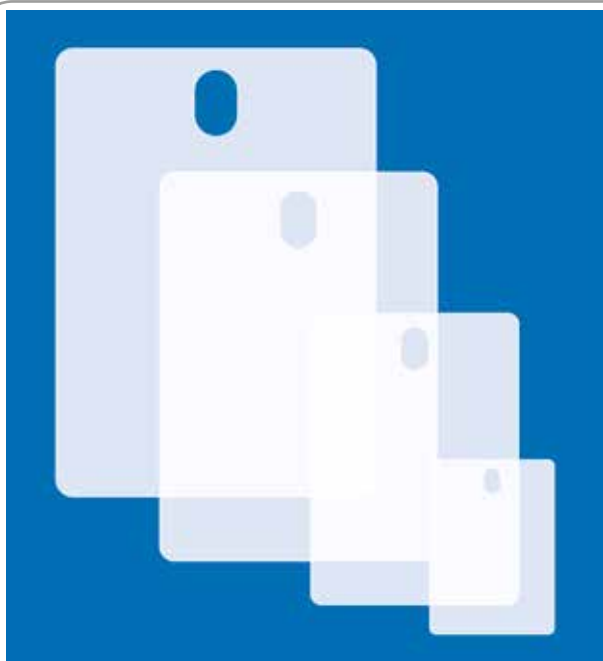

3300

Gabarito para Roupas (kit c/ 4 Tamanhos)

Gabarito para Roupas (kit con 4 Talas)

 C.L.A. 250 x 0 x 345 mm

 H 20un.

 Espessura 0,153 mm



- Produzido em chapa de PP.
- O queridinho das personal organizers.
- Roupas dobradas sempre do mesmo tamanho para organizar armários e gavetas.



3301

Gabarito para Roupas Corrugado (kit c/ 5 Tamanhos)

Gabarito para Roupas (kit con 5 Talas)

 C.L.A. 250 x 0 x 345 mm

 E 12un.

 Espessura 0,9 mm



- Produzido em PP corrugado.
- O queridinho das personal organizers.
- Roupas dobradas sempre do mesmo tamanho para organizar armários e gavetas.



2406



Cesto Organizador M

Cesto Organizador M

 C.L.A. 225 x 225 x 183 mm

 Espessura 0,9 mm

 9,2 L

 6un.  6un.
 6un.



- Alças anatômicas.
- Design elegante.



2405

Cesto Organizador P

Cesto Organizador P

 C.L.A. 170 x 170 x 138 mm

 Espessura 0,9 mm

 3,9 L

 6un.



- Alças anatômicas.
- Design elegante.



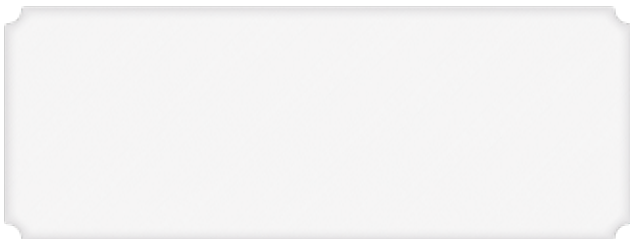



4100

Forro para Prateleiras e Armários

Revestimiento para Estantes y Gabinetes

 C.L.A. 877 x 327 x 0 mm

H 100un.

 Espessura 0,7 mm



- Textura Line.
- Ideal para expor produtos em prateleiras vazadas.

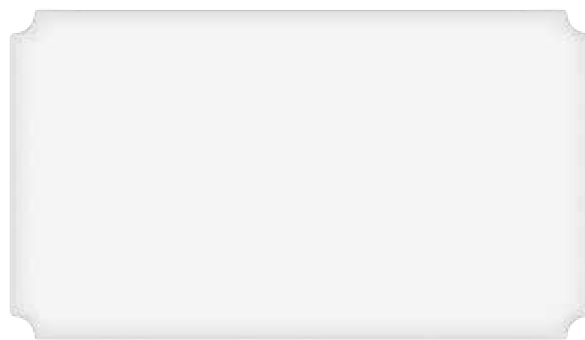

4101

Forro para Prateleiras e Armários

Revestimiento para Estantes y Gabinetes

 C.L.A. 577 x 327 x 0 mm

H 100un.

 Espessura 0,7 mm



- Textura Line.
- Ideal para expor produtos em prateleiras vazadas.



4105

Forro para Gavetas e Armários

Revestimiento para Cajones y Armarios

 C.L.A. 300 x 1500 x 0 mm

H 12un.

 Espessura 0,35 mm



- Textura lisa soft touch.
- Fácil limpeza
- Possui base com EVA para não deslizar.
- Pode ser recortado para encaixar-se ao tamanho necessário.



4106

Forro para Gavetas e Armários

Revestimiento para Cajones y Armarios

 C.L.A. 500 x 1500 x 0 mm

H 12un.

 Espessura 0,35 mm



- Textura lisa soft touch.
- Fácil limpeza
- Possui base com EVA para não deslizar.
- Pode ser recortado para encaixar-se ao tamanho necessário.

CÓDIGO	NOME	EAN13	MEDIDAS	ESPESSURA	GRAMATURA	EAN13 MASTER	MEDIDAS CAIXA	CUBAGEM	PESO TOTAL	IP1	NCM
0001.X.0050.2	PASTA SUSP.KRAFT PLAST.HT.PL.C/GP	7897832820127	361 x 0 x 240	0	170 a 200g/m²	7897832820134	428 x 298 x 115	0	3	10	4820.90.00
0002.X.0050.2	PASTA SUSP.KRAFT HT.PL.C/GP	7897832814164	361 x 0 x 240	0	170 a 200g/m²	7897832814119	428 x 298 x 115	0	3	10	4820.90.00
0004.X.0050.2	PASTA SUSP.KRAFT ARAME C/GP	7897832803410	261 x 0 x 240	0	170 a 200g/m²	7897832800013	428 x 298 x 100	0	3	10	4820.90.00
0005.C.0050.2	PASTA SUSP.DELLOPLAST AZ.GP	7897832808491	361 x 0 x 240	0		7897832802239	428 x 300 x 126	0	4	7	4202.12.10
0005.H.0050.2	PASTA SUSP.DELLOPLAST C/GP CR	7897832808514	361 x 0 x 240	0		7897832802253	428 x 300 x 126	0	4	7	4202.12.10
0005.I.0050.2	PASTA SUSP.DELLOPLAST FM.GP	7897832808521	361 x 0 x 240	0		7897832802277	428 x 300 x 126	0	4	7	4202.12.10
0006.PE.0006	PASTA SUSPENSIVA EXECUTIVE C/ 12 DIVISORIAS PRETA	7897832874540	335 x 30 x 240	0		7897832874557	418 x 278 x 124	0	2	7	4202.12.10
0010.X.0006	PASTA SUSP.KRAFTSUPER 12 DIV.	7897832820042	363 x 263 x 15	0	420g/m²	7897832820059	420 x 308 x 112	0	4	10	4820.90.00
0012.BP.0030	ENVELOPE COM BOTAO A4 SERENA AZUL PASTEL	7897832869270	330 x 0 x 240	0		7897832869287	345 x 240 x 160	0	1	7	4202.12.10
0012.LP.0030	ENVELOPE COM BOTAO A4 SERENA LILAS PASTEL	7897832869300	330 x 0 x 240	0		7897832869317	262 x 250 x 150	0	1	7	4202.12.10
0012.SS.0030	ENVELOPE COM BOTAO A4 SERENA SORTIDO	7897832870948	330 x 0 x 240	0		7897832870955	262 x 250 x 150	0	1	7	4202.12.10
0012.VP.0030	ENVELOPE COM BOTAO A4 SERENA VERDE PASTEL	7897832869331	330 x 0 x 240	0		7897832869348	262 x 250 x 150	0	1	7	4202.12.10
0012.WP.0030	ENVELOPE COM BOTAO A4 SERENA ROSA PASTEL	7897832869362	330 x 0 x 240	0		7897832869379	262 x 250 x 150	0	1	7	4202.12.10
0013.H.0030	ENVELOPE COM BOTAO A4 CRISTAL	7897832873086	330 x 0 x 240	0		7897832873093	262 x 250 x 150	0	1	7	4202.12.10
0013.P.0030	ENVELOPE COM BOTAO A4 PRETO	7897832873109	330 x 0 x 240	0		7897832873116	262 x 250 x 150	0	1	7	4202.12.10
0014.C.0030	ENVELOPE COM BOTAO A4 FULL COLOR AZUL	7897832888240	330 x 0 x 240	0		7897832888257	262 x 250 x 150	0	1	7	4202.12.10
0014.K.0030	ENVELOPE COM BOTAO A4 FULL COLOR LARANJA	7897832888264	330 x 0 x 240	0		7897832888271	262 x 250 x 150	0	1	7	4202.12.10
0014.Q.0030	ENVELOPE COM BOTAO A4 FULL COLOR PINK	7897832888288	330 x 0 x 240	0		7897832888295	262 x 250 x 150	0	1	7	4202.12.10
0014.R.0030	ENVELOPE COM BOTAO A4 FULL COLOR ROXO	7897832888301	330 x 0 x 240	0		7897832888318	262 x 250 x 150	0	1	7	4202.12.10
0014.S.0030	ENVELOPE COM BOTAO A4 FULL COLOR SORTIDA	7897832889452	330 x 0 x 240	0		7897832889469	262 x 250 x 150	0	1	7	4202.12.10
0014.VL.0030	ENVELOPE COM BOTAO A4 FULL COLOR VERDE LIMAO	7897832888226	330 x 0 x 240	0		7897832888233	262 x 250 x 150	0	1	7	4202.12.10
0018.01.0030	ENVELOPE COM BOTAO A4 PANDA ROSA	7897832889858	330 x 0 x 240	0		7897832889865	262 x 250 x 150	0	1	7	4202.12.10
0018.02.0030	ENVELOPE COM BOTAO A4 PANDA VERDE	7897832889872	330 x 0 x 240	0		7897832889889	262 x 250 x 150	0	1	7	4202.12.10
0020.X.0050.2	PASTA SUSP. KRAFTSUPER HT.PL.C/GP	7897832820219	361 x 0 x 240	0	265 a 300g/m²	7897832820226	425 x 268 x 210	0	4	10	4820.90.00
0022.X.0050.2	PASTA SUSP.KRAFTSUPER ARAME C/GP	7897832807876	361 x 0 x 240	0	265 a 300g/m²	7897832800037	425 x 268 x 210	0	4	10	4820.90.00
0038.F.0050.2	PASTA SUSP.MARM.CT.HT.PL.C/GP	7897832814171	361 x 0 x 240	0	336 a 350g/m²	7897832814126	425 x 295 x 125	0	4	10	4820.90.00
0039.F.0050.2	PASTA SUSP.MARM.PLAST.CT.HT.PL.C/GP	7897832814188	361 x 0 x 240	0	336 a 350g/m²	7897832814133	428 x 298 x 120	0	5	10	4820.90.00
0039.T.0050.2	PASTA SUSP.MARM.PLAST.VD.HT.PL.C/GP	7897832809436	361 x 0 x 240	0	336 a 350g/m²	7897832803823	428 x 298 x 120	0	5	10	4820.90.00
0040.F.0050.2	PASTA SUSP.MARM.PLAST.CT.ARAME C/GP	7897832807890	361 x 0 x 240	0	336 a 350g/m²	7897832802260	420 x 298 x 120	0	5	10	4820.90.00
0041.F.0050.2	PASTA SUSP.MARM.CT.ARAME C/GP	7897832807883	361 x 0 x 240	0	336 a 350g/m²	7897832800501	428 x 298 x 120	0	5	10	4820.90.00
0044.F.0050.2	PASTA SUSP MARMORIZADA PINTADA CASTANHO C/GP	7897832838290	361 x 0 x 240	0	230g/m²	7897832839099	425 x 297 x 126	0	4	10	4820.90.00
0045.F.0050.2	PASTA SUSP.MARMORIZ. PLASTIF. CARTAO PINTADO CAST. C/GP	7897832838313	361 x 0 x 240	0	240g/m²	7897832839723	420 x 290 x 112	0	4	10	4820.90.00
0099.A.0048.2	PASTA SUSP.DELLOPLUS AM.C/GP PCT.C/06UN.	7897832807906	361 x 0 x 240	0	250 a 280g/m²	7897832806275	425 x 270 x 190	0	4	10	4820.90.00
0099.C.0048.2	PASTA SUSP.DELLOPLUS AZ.C/GP PCT.C/06UN.	7897832807913	361 x 0 x 240	0	250 a 280g/m²	7897832806299	425 x 270 x 190	0	4	10	4820.90.00
0099.E.0048.2	PASTA SUSP.DELLOPLUS BR.C/GP PCT.C/06UN.	7897832807968	361 x 0 x 240	0	250 a 280g/m²	7897832806312	425 x 270 x 190	0	4	10	4820.90.00
0099.O.0048.2	PASTA SUSP.DELLOPLUS PR.C/GP PCT.C/06UN.	7897832807999	361 x 0 x 240	0	250 a 280g/m²	7897832807043	425 x 270 x 190	0	4	10	4820.90.00
0099.P.0048.2	PASTA SUSP.DELLOPLUS PT.C/GP PCT.C/06UN.	7897832807937	361 x 0 x 240	0	250 a 280g/m²	7897832806336	425 x 270 x 190	0	4	10	4820.90.00
0099.T.0048.2	PASTA SUSP.DELLOPLUS VD.C/GP PCT.C/06UN.	7897832807944	361 x 0 x 240	0	250 a 280g/m²	7897832806350	425 x 270 x 190	0	4	10	4820.90.00
0099.U.0048.2	PASTA SUSP.DELLOPLUS VM.C/GP PCT.C/06UN.	7897832807951	361 x 0 x 240	0	250 a 280g/m²	7897832806374	425 x 270 x 190	0	4	10	4820.90.00
0116.E.0020	VISOR E ETIQUETA DELLO BRANCA	7897832800068	80 x 60 x 15	0	120g/m²	7897832801638	181 x 140 x 110	0	0	10	3926.10.00
0116.E.0040	VISOR E ETIQUETA DELLO BRANCA PCT COM 25 UN	7897832857673	80 x 62 x 10	0	120g/m²	7897832857680	181 x 140 x 110	0	1	10	3926.10.00
0199.A.0050	PASTA ABA ELASTICO DELLOPLEX AM.	7897832804790	350 x 0 x 240	0	250 a 270g/m²	7897832804806	365 x 245 x 210	0	3	10	4820.90.00
0199.C.0050	PASTA ABA ELASTICO DELLOPLEX AZ.	7897832804813	350 x 0 x 240	0	250 a 270g/m²	7897832804820	365 x 245 x 210	0	3	10	4820.90.00
0199.E.0050	PASTA ABA ELASTICO DELLOPLEX BR.	7897832804899	350 x 0 x 240	0	250 a 270g/m²	7897832804905	365 x 245 x 210	0	3	10	4820.90.00
0199.P.0050	PASTA ABA ELASTICO DELLOPLEX PT.	7897832804837	350 x 0 x 240	0	250 a 270g/m²	7897832804844	365 x 245 x 210	0	3	10	4820.90.00
0199.S.0050	PASTA ABA ELASTICO DELLOPLEX SR.	7897832836272	350 x 0 x 240	0	250 a 270g/m²	7897832832472	365 x 245 x 210	0	3	10	4820.90.00
0199.T.0050	PASTA ABA ELASTICO DELLOPLEX VD.	7897832804851	350 x 0 x 240	0	250 a 270g/m²	7897832804868	365 x 245 x 210	0	3	10	4820.90.00
0199.U.0050	PASTA ABA ELASTICO DELLOPLEX VM.	7897832804875	350 x 0 x 240	0	250 a 270g/m²	7897832804882	365 x 245 x 210	0	3	10	4820.90.00
0203.A.0050.2	PASTA CLASSIF.DELLOCLEAN AM.C/IMPRES. E GP	7897832825269	345 x 0 x 235	0	480g/m²	7897832823319	363 x 358 x 120	0	5	10	4820.30.00
0203.C.0050.2	PASTA CLASSIF.DELLOCLEAN AZ.C/IMPRES. E GP	7897832825276	345 x 0 x 235	0	480g/m²	7897832823371	363 x 358 x 120	0	5	10	4820.30.00
0203.G.0050.2	PASTA CLASSIF.DELLOCLEAN CZ.C/IMPRES. E GP	7897832825283	345 x 0 x 235	0	480g/m²	7897832823432	363 x 358 x 120	0	5	10	4820.30.00
0204.A.0050.2	PASTA CLASSIF.DELLOCLEAN AM.C/GP	7897832805612	345 x 1 x 235	0	480g/m²	7897832807142	363 x 358 x 120	0	5	10	4820.30.00
0204.C.0050.2	PASTA CLASSIF.DELLOCLEAN AZ.C/GP	7897832831567	345 x 1 x 235	0	480g/m²	7897832807159	363 x 358 x 120	0	5	10	4820.30.00
0204.G.0050.2	PASTA CLASSIF.DELLOCLEAN CZ.C/GP	7897832831574	345 x 1 x 235	0	480g/m²	7897832807180	363 x 358 x 120	0	5	10	4820.30.00
0204.T.0050.2	PASTA CLASSIF.DELLOCLEAN VD.C/GP	7897832805650	345 x 1 x 235	0	480g/m²	7897832807166	363 x 358 x 120	0	5	10	4820.30.00
0205.A.0050.2	PASTA CLASSIF.DELLOCLEAN PLAST.AM.C/GP	7897832805667	345 x 1 x 235	0	480g/m²	7897832807098	360 x 360 x 125	0	5	10	4820.30.00
0205.C.0050.2	PASTA CLASSIF.DELLOCLEAN PLAST.AZ.C/GP	7897832805674	345 x 1 x 235	0	480g/m²	7897832807104	360 x 360 x 125	0	5	10	4820.30.00
0205.G.0050.2	PASTA CLASSIF.DELLOCLEAN PLAST.CZ.C/GP	7897832805681	345 x 1 x 235	0	480g/m²	7897832807135	360 x 360 x 125	0	5	10	4820.30.00
0205.T.0050.2	PASTA CLASSIF.DELLOCLEAN PLAST.VD.C/GP	7897832805704	345 x 1 x 235	0	480g/m²	7897832807111	360 x 360 x 125	0	5	10	4820.30.00
0209.A.0050.2	PASTA CLASSIF. DELLOCLEAN 290GRS AMARELA C/GP	7897832838405	345 x 0 x 235	0	290g/m²	7897832838412	370 x 338 x 90	0	3	10	4820.30.00
0209.C.0050.2	PASTA CLASSIF. DELLOCLEAN 290GRS AZUL C/GP	7897832838436	345 x 0 x 235	0	290g/m²	7897832838443	370 x 338 x 90	0	3	10	4820.30.00
0209.G.0050.2	PASTA CLASSIF. DELLOCLEAN 290GRS CINZA C/GP	7897832838467	345 x 0 x 235	0	290g/m²	7897832838474	370 x 338 x 90	0	3	10	4820.30.00
0209.T.0050.2	PASTA CLASSIF. DELLOCLEAN 290GRS VERDE C/GP	7897832838528	345 x 0 x 235	0	290g/m²	7897832838535	370 x 338 x 90	0	3	10	4820.30.00
0211.A.0050.2	PASTA CLASSIF.DELLOCLEAN AM.C/IMPRES.290GRS C/GP	7897832838764	345 x 0 x 235	0	290g/m²	7897832838771	370 x 338 x 90	0	3	10	4820.30.00
0211.C.0050.2	PASTA CLASSIF.DELLOCLEAN AZ.C/IMPRES.290GRS C/GP	7897832838795	345 x 0 x 235	0	290g/m²	7897832838801	370 x 338 x 90	0	3	10	4820.30.00

CÓDIGO	NOME	EAN13	MEDIDAS	ESPESSURA	GRAMATURA	EAN13 MASTER	MEDIDAS CAIXA	CUBAGEM	PESO TOTAL	IP1	NCM
0211.G.0050.2	PASTA CLASSIF.DELLOCLEAN C.Z./IMPRES.290GRS C/GP	7897832838825	345 x 0 x 235		290g/m²	7897832838832	370 x 338 x 90	0	3	10	4820.30.00
0211.T.0050.2	PASTA CLASSIF.DELLOCLEAN VD.C./IMPRES.290GRS C/GP	7897832838917	345 x 0 x 235		290g/m²	7897832838924	370 x 338 x 90	0	3	10	4820.30.00
0214.P.0030	PASTA COM BOLSA PARA DOCUMENTOS EXECUTIVE PRETA	7897832875059	220 x 0 x 310	0		7897832875066	355 x 280 x 120	0	2	7	4202.12.10
0233.A.0050	PASTA ABA ELASTICO OFICIO TOP LINE AMARELA	7897832844321	335 x 0 x 235	0		7897832844338	349 x 251 x 250	0	6	7	4202.12.10
0233.C.0050	PASTA ABA ELASTICO OFICIO TOP LINE AZUL	7897832844345	335 x 0 x 235	0		7897832844352	349 x 251 x 250	0	5	7	4202.12.10
0233.H.0050	PASTA ABA ELASTICO OFICIO TOP LINE CRISTAL	7897832844369	335 x 0 x 235	0		7897832844376	349 x 251 x 250	0	5	7	4202.12.10
0233.I.0050	PASTA ABA ELASTICO OFICIO TOP LINE FUME	7897832844383	335 x 0 x 235	0		7897832844390	349 x 251 x 250	0	5	7	4202.12.10
0233.Q.0050	PASTA ABA ELASTICO OFICIO TOP LINE ROSA	7897832844420	335 x 0 x 235	0		7897832844437	349 x 251 x 250	0	5	7	4202.12.10
0233.S.0050	PASTA ABA ELASTICO OFICIO TOP LINE SORTIDA	7897832847544	335 x 0 x 235	0		7897832845281	349 x 251 x 250	0	5	7	4202.12.10
0233.T.0050	PASTA ABA ELASTICO OFICIO TOP LINE VERDE	7897832844468	335 x 0 x 235	0		7897832844475	349 x 251 x 250	0	5	7	4202.12.10
0233.U.0050	PASTA ABA ELASTICO OFICIO TOP LINE VERMELHA	7897832845328	335 x 0 x 235	0		7897832845335	349 x 251 x 250	0	5	7	4202.12.10
0234.C.0050	PASTA ABA ELASTICO OFICIO LOMBO 2CM TOP LINE AZUL	7897832844505	335 x 20 x 235	0		7897832844512	425 x 285 x 350	0	7	7	4202.12.10
0234.H.0050	PASTA ABA ELASTICO OFICIO LOMBO 2CM TOP LINE CRISTAL	7897832844529	335 x 20 x 235	0		7897832844536	425 x 285 x 350	0	7	7	4202.12.10
0234.I.0050	PASTA ABA ELASTICO OFICIO LOMBO 2CM TOP LINE FUME	7897832844543	335 x 20 x 235	0		7897832844550	425 x 285 x 350	0	7	7	4202.12.10
0234.Q.0050	PASTA ABA ELASTICO OFICIO LOMBO 2CM TOP LINE ROSA	7897832844581	335 x 20 x 235	0		7897832844598	425 x 285 x 350	0	7	7	4202.12.10
0234.S.0050	PASTA ABA ELASTICO OFICIO LOMBO DE 2CM TOP LINE SORTIDA	7897832847551	335 x 20 x 235	0		7897832845298	425 x 285 x 350	0	7	7	4202.12.10
0234.T.0050	PASTA ABA ELASTICO OFICIO LOMBO 2CM TOP LINE VERDE	7897832844628	335 x 20 x 235	0		7897832844635	425 x 285 x 350	0	7	7	4202.12.10
0234.U.0050	PASTA ABA ELASTICO OFICIO LOMBO 2CM TOP LINE VERMELHA	7897832845342	335 x 20 x 235	0		7897832845359	425 x 285 x 350	0	7	7	4202.12.10
0235.C.0050	PASTA ABA ELASTICO OFICIO LOMBO 3CM TOP LINE AZUL	7897832844666	335 x 30 x 235	0		7897832844673	425 x 285 x 350	0	8	7	4202.12.10
0235.H.0100	PASTA ABA ELASTICO OF. LB 3CM TOP LINE CRISTAL PCTE C/10	7897832844680	335 x 30 x 235	0		7897832844697	425 x 285 x 350	0	9	7	4202.12.10
0235.I.0050	PASTA ABA ELASTICO OFICIO LOMBO 3CM TOP LINE FUME	7897832844703	335 x 30 x 235	0		7897832844710	425 x 285 x 350	0	8	7	4202.12.10
0235.S.0050	PASTA ABA ELASTICO OFICIO LOMBO 3CM TOP LINE SORTIDA	7897832847568	335 x 30 x 235	0		7897832845304	425 x 285 x 350	0	8	7	4202.12.10
0236.C.0050	PASTA ABA ELASTICO OFICIO LOMBO 4CM TOP LINE AZUL	7897832844826	335 x 40 x 235	0		7897832844833	430 x 305 x 350	0	9	7	4202.12.10
0236.H.0050	PASTA ABA ELASTICO OFICIO LOMBO 4CM TOP LINE CRISTAL	7897832844840	335 x 40 x 235	0		7897832844857	430 x 305 x 350	0	9	7	4202.12.10
0236.I.0050	PASTA ABA ELASTICO OFICIO LOMBO 4CM TOP LINE FUME	7897832844864	335 x 40 x 235	0		7897832844871	430 x 305 x 350	0	9	7	4202.12.10
0236.Q.0050	PASTA ABA ELASTICO OFICIO LOMBO 4CM TOP LINE ROSA	7897832844901	335 x 40 x 235	0		7897832844918	430 x 305 x 350	0	9	7	4202.12.10
0236.S.0050	PASTA ABA ELASTICO OFICIO LOMBO 4CM TOP LINE SORTIDA	7897832847575	335 x 40 x 235	0		7897832845311	430 x 305 x 350	0	9	7	4202.12.10
0236.T.0050	PASTA ABA ELASTICO OFICIO LOMBO 4CM TOP LINE VERDE	7897832844949	335 x 40 x 235	0		7897832844956	430 x 305 x 350	0	9	7	4202.12.10
0236.U.0050	PASTA ABA ELASTICO OFICIO LOMBO 4CM TOP LINE VERMELHA	7897832845380	335 x 40 x 235	0		7897832845397	430 x 305 x 350	0	9	7	4202.12.10
0237.C.0050	PASTA ABA ELASTICO OFICIO LOMBO 5,5CM TOP LINE AZUL	7897832846448	335 x 55 x 235	0		7897832846455	430 x 305 x 350	0	10	7	4202.12.10
0237.H.0050	PASTA ABA ELASTICO OFICIO LOMBO 5,5CM TOP LINE CRISTAL	7897832846479	335 x 55 x 235	0		7897832846486	430 x 305 x 350	0	10	7	4202.12.10
0237.I.0050	PASTA ABA ELASTICO OFICIO LOMBO 5,5CM TOP LINE FUME	7897832846509	335 x 55 x 235	0		7897832846516	430 x 305 x 350	0	10	7	4202.12.10
0237.S.0050	PASTA ABA ELASTICO OFICIO LOMBO 5,5CM TOP LINE SORTIDA	7897832849630	335 x 55 x 235	0		7897832849647	430 x 305 x 350	0	10	7	4202.12.10
0241.C.0050	PASTA ABA ELASTICO OFICIO DELLOFINE AZUL	7897832833462	335 x 0 x 235	0		7897832833479	262 x 250 x 150	0	3	7	4202.12.10
0241.H.0050	PASTA ABA ELASTICO OFICIO DELLOFINE CRISTAL	7897832833486	335 x 0 x 235	0		7897832833493	262 x 250 x 150	0	3	7	4202.12.10
0241.P.0050	PASTA ABA ELASTICO OFICIO DELLOFINE PRETA	7897832840019	335 x 0 x 235	0		7897832840026	262 x 250 x 150	0	3	7	4202.12.10
0241.Q.0050	PASTA ABA ELASTICO OFICIO DELLOFINE ROSA	7897832839938	335 x 0 x 235	0		7897832839945	262 x 250 x 150	0	3	7	4202.12.10
0241.R.0050	PASTA ABA ELASTICO OFICIO DELLOFINE ROXA	7897832842419	335 x 0 x 235	0		7897832842426	262 x 250 x 150	0	3	7	4202.12.10
0241.S.0050	PASTA ABA ELASTICO OFICIO DELLOFINE SORTIDA	7897832835039	335 x 0 x 235	0		7897832834308	262 x 250 x 150	0	3	7	4202.12.10
0241.T.0050	PASTA ABA ELASTICO OFICIO DELLOFINE VERDE	7897832833547	335 x 0 x 235	0		7897832833554	262 x 250 x 150	0	3	7	4202.12.10
0241.U.0050	PASTA ABA ELASTICO OFICIO DELLOFINE VERMELHA	7897832833561	335 x 0 x 235	0		7897832833578	262 x 250 x 150	0	3	7	4202.12.10
0242.C.0050	PASTA ABA ELAS. OFICIO LOMBO 2CM DELLOFINE AZUL	7897832833608	335 x 20 x 235	0		7897832833615	300 x 290 x 350	0	5	7	4202.12.10
0242.I.0050	PASTA ABA ELAS. OFICIO LOMBO 2CM DELLOFINE FUME	7897832833646	335 x 20 x 235	0		7897832833653	300 x 290 x 350	0	5	7	4202.12.10
0246.BP.0050	PASTA ABA ELASTICO OFICIO LINHO SERENA AZUL PASTEL	7897832862264	335 x 0 x 235	0		7897832862271	370 x 268 x 202	0	5	7	4202.12.10
0246.LP.0050	PASTA ABA ELASTICO OFICIO LINHO SERENA LILAS PASTEL	7897832862387	335 x 0 x 235	0		7897832862394	370 x 268 x 202	0	5	7	4202.12.10
0246.S.0050	PASTA ABA ELASTICO OFICIO LINHO SERENA SORTIDA	7897832863629	335 x 0 x 235	0		7897832863636	370 x 268 x 202	0	5	7	4202.12.10
0246.VP.0050	PASTA ABA ELASTICO OFICIO LINHO SERENA VERDE PASTEL	7897832862295	335 x 0 x 235	0		7897832862301	370 x 268 x 202	0	5	7	4202.12.10
0246.WP.0050	PASTA ABA ELASTICO OFICIO LINHO SERENA ROSA PASTEL	7897832862356	335 x 0 x 235	0		7897832862363	370 x 268 x 202	0	5	7	4202.12.10
0247.BP.0050	PASTA ABA ELASTICO OF. LB 2CM LINHO SERENA AZUL PASTEL	7897832862448	335 x 20 x 235	0		7897832862455	370 x 270 x 205	0	5	7	4202.12.10
0247.LP.0050	PASTA ABA ELASTICO OF. LB 2CM LINHO SERENA LILAS PASTEL	7897832862479	335 x 20 x 235	0		7897832862486	370 x 270 x 205	0	5	7	4202.12.10
0247.S.0050	PASTA ABA ELASTICO OF. LB 2CM LINHO SERENA SORTIDA	7897832863650	335 x 20 x 235	0		7897832863667	370 x 270 x 205	0	5	7	4202.12.10
0247.VP.0050	PASTA ABA ELASTICO OF. LB 2CM LINHO SERENA VERDE PASTEL	7897832862509	335 x 20 x 235	0		7897832862516	370 x 270 x 205	0	5	7	4202.12.10
0247.WP.0050	PASTA ABA ELASTICO OF. LB 2CM LINHO SERENA ROSA PASTEL	7897832862530	335 x 20 x 235	0		7897832862547	370 x 270 x 205	0	5	7	4202.12.10
0248.BP.0050	PASTA ABA ELASTICO OF. LB 3CM LINHO SERENA AZUL PASTEL	7897832862592	335 x 30 x 235	0		7897832862608	354 x 292 x 210	0	6	7	4202.12.10
0248.LP.0050	PASTA ABA ELASTICO OF. LB 3CM LINHO SERENA LILAS PASTEL	7897832862622	335 x 30 x 235	0		7897832862639	354 x 292 x 210	0	6	7	4202.12.10
0248.S.0050	PASTA ABA ELASTICO OF. LB 3CM LINHO SERENA SORTIDA	7897832863681	335 x 30 x 235	0		7897832863698	354 x 292 x 210	0	6	7	4202.12.10
0248.WP.0050	*PASTA ABA ELASTICO OF. LB 3CM LINHO SERENA ROSA PASTEL	7897832862684	335 x 30 x 235	0		7897832862691	354 x 292 x 210	0	6	7	4202.12.10
0249.BP.0050	PASTA ABA ELASTICO OF. LB 4CM LINHO SERENA AZUL PASTEL	7897832862745	335 x 40 x 235	0		7897832862752	354 x 292 x 210	0	7	7	4202.12.10
0249.LP.0050	PASTA ABA ELASTICO OF. LB 4CM LINHO SERENA LILAS PASTEL	7897832862776	335 x 40 x 235	0		7897832862783	354 x 292 x 210	0	7	7	4202.12.10
0249.S.0050	PASTA ABA ELASTICO OF. LB 4CM LINHO SERENA SORTIDA	7897832863711	335 x 40 x 235	0		7897832863728	354 x 292 x 210	0	7	7	4202.12.10
0249.VP.0050	PASTA ABA ELASTICO OF. LB 4CM LINHO SERENA VERDE PASTEL	7897832862806	335 x 40 x 235	0		7897832862813	354 x 292 x 210	0	7	7	4202.12.10
0249.WP.0050	PASTA ABA ELASTICO OF. LB 4CM LINHO SERENA ROSA PASTEL	7897832862837	335 x 40 x 235	0		7897832862844	354 x 292 x 210	0	7	7	4202.12.10
0250.BP.0050	PASTA ABA ELASTICO OF. LB 5,5CM LINHO SERENA AZUL PASTEL	7897832862899	335 x 55 x 235	0		7897832862905	365 x 297 x 351	0	9	7	4202.12.10
0250.LP.0050	PASTA ABA ELASTICO OF. LB 5,5CM LINHO SERENA LILAS PASTEL	7897832862929	335 x 55 x 235	0		7897832862936	365 x 297 x 351	0	9	7	4202.12.10
0250.S.0050	PASTA ABA ELASTICO OF. LB 5,5CM LINHO SERENA SORTIDA	7897832863742	335 x 55 x 235	0		7897832863759	365 x 297 x 351	0	9	7	4202.12.10

CÓDIGO	NOME	EAN13	MEDIDAS	ESPESSURA	GRAMATURA	EAN13 MASTER	MEDIDAS CAIXA	CUBAGEM	PESO TOTAL	IP1	NCM
0250.WP.0050	PASTA ABA ELASTICO OF. LB 5,5CM LINHO SERENA ROSA PASTEL	7897832862981	335 x 55 x 235	0		7897832862998	365 x 297 x 351	0	9	7	4202.12.10
0252.A.0050	PASTA ABA 1/2 OFICIO LINE AMARELA	7897832805056	245 x 0 x 180	0		7897832805063	255 x 215 x 195	0	2	7	4202.12.10
0252.C.0050	PASTA ABA 1/2 OFICIO LINE AZUL	7897832805070	245 x 0 x 180	0		7897832805087	255 x 215 x 195	0	2	7	4202.12.10
0252.H.0050	PASTA ABA 1/2 OFICIO LINE CRISTAL	7897832805094	245 x 0 x 180	0		7897832805100	255 x 215 x 195	0	2	7	4202.12.10
0252.I.0050	PASTA ABA 1/2 OFICIO LINE FUME	7897832805117	245 x 0 x 180	0		7897832805124	255 x 215 x 195	0	2	7	4202.12.10
0252.Q.0050	PASTA ABA 1/2 OFICIO LINE ROSA	7897832843096	245 x 0 x 180	0		7897832843102	255 x 215 x 195	0	2	7	4202.12.10
0252.R.0050	PASTA ABA 1/2 OFICIO LINE ROXA	7897832845663	245 x 0 x 180	0		7897832845670	255 x 215 x 195	0	2	7	4202.12.10
0252.S.0050	PASTA ABA 1/2 OFICIO LINE SORTIDA	7897832848923	245 x 0 x 180	0		7897832801614	255 x 215 x 195	0	2	7	4202.12.10
0252.T.0050	PASTA ABA 1/2 OFICIO LINE VERDE	7897832805155	245 x 0 x 180	0		7897832805162	255 x 215 x 195	0	2	7	4202.12.10
0252.U.0050	PASTA ABA 1/2 OFICIO LINE VERMELHA	7897832805131	245 x 0 x 180	0		7897832805148	255 x 215 x 195	0	2	7	4202.12.10
0253.C.0050	PASTA ABA 1/2 OFICIO LOMBO 2,5 LINE AZUL	7897832804097	245 x 25 x 180	0		7897832804103	255 x 215 x 195	0	3	7	4202.12.10
0253.H.0050	PASTA ABA 1/2 OFICIO LOMBO 2,5 LINE CRISTAL	7897832804110	245 x 25 x 180	0		7897832804127	255 x 215 x 195	0	3	7	4202.12.10
0253.I.0050	PASTA ABA 1/2 OFICIO LOMBO 2,5 LINE FUME	7897832804134	245 x 25 x 180	0		7897832804141	255 x 215 x 195	0	3	7	4202.12.10
0253.S.0050	PASTA ABA 1/2 OFICIO LOMBO 2,5 LINE SORTIDA	7897832849340	245 x 25 x 180	0		7897832801621	255 x 215 x 195	0	3	7	4202.12.10
0254.A.0050	PASTA ABA ELASTICO OFICIO LINE AMARELA	7897832840415	335 x 0 x 235	0		7897832840422	345 x 240 x 160	0	3	7	4202.12.10
0254.C.0050	PASTA ABA ELASTICO OFICIO LINE AZUL	7897832840453	335 x 0 x 235	0		7897832840460	345 x 240 x 160	0	3	7	4202.12.10
0254.H.0050	PASTA ABA ELASTICO OFICIO LINE CRISTAL	7897832840491	335 x 0 x 235	0		7897832840507	345 x 240 x 160	0	3	7	4202.12.10
0254.I.0050	PASTA ABA ELASTICO OFICIO LINE FUME	7897832840538	335 x 0 x 235	0		7897832840545	345 x 240 x 160	0	3	7	4202.12.10
0254.Q.0050	PASTA ABA ELASTICO OFICIO LINE ROSA PINK	7897832845427	335 x 0 x 235	0		7897832845434	345 x 240 x 160	0	3	7	4202.12.10
0254.R.0050	PASTA ABA ELASTICO OFICIO LINE ROXA	7897832845458	335 x 0 x 235	0		7897832845465	345 x 240 x 160	0	3	7	4202.12.10
0254.S.0050	PASTA ABA ELASTICO OFICIO LINE SORTIDA	7897832849357	335 x 0,33 x 235	0		7897832848169	345 x 240 x 160	0	3	7	4202.12.10
0254.S.0100	PASTA ABA ELASTICO OFICIO LINE SORTIDA	7897832849357	335 x 0,33 x 235	0		7897832849036	345 x 285 x 293	0	6	7	4202.12.10
0254.T.0050	PASTA ABA ELASTICO OFICIO LINE VERDE	7897832840576	335 x 0 x 235	0		7897832840583	345 x 240 x 160	0	3	7	4202.12.10
0254.U.0050	PASTA ABA ELASTICO OFICIO LINE VERMELHA	7897832840613	335 x 0 x 235	0		7897832840620	345 x 240 x 160	0	3	7	4202.12.10
0255.A.0050	PASTA ABA ELAS. OFICIO LOMBO 2CM LINE AMARELA	7897832840651	335 x 20 x 235	0		7897832840668	345 x 280 x 165	0	4	7	4202.12.10
0255.C.0050	PASTA ABA ELAS. OFICIO LOMBO 2CM LINE AZUL	7897832840699	335 x 20 x 235	0		7897832840705	345 x 280 x 165	0	4	7	4202.12.10
0255.H.0050	PASTA ABA ELAS. OFICIO LOMBO 2CM LINE CRISTAL	7897832840736	335 x 20 x 235	0		7897832840743	345 x 280 x 165	0	4	7	4202.12.10
0255.I.0050	PASTA ABA ELAS. OFICIO LOMBO 2CM LINE FUME	7897832840774	335 x 20 x 235	0		7897832840781	345 x 280 x 165	0	4	7	4202.12.10
0255.Q.0050	PASTA ABA ELAS. OFICIO LOMBO 2CM LINE ROSA PINK	7897832845489	335 x 20 x 235	0		7897832845496	345 x 280 x 165	0	4	7	4202.12.10
0255.R.0050	PASTA ABA ELAS. OFICIO LOMBO 2CM LINE ROXA	7897832845519	335 x 20 x 235	0		7897832845526	345 x 280 x 165	0	4	7	4202.12.10
0255.S.0050	PASTA ABA ELAS. OFICIO LOMBO 2CM LINE SORTIDA	7897832849364	335 x 20 x 235	0		7897832848190	345 x 280 x 165	0	4	7	4202.12.10
0255.T.0050	PASTA ABA ELAS. OFICIO LOMBO 2CM LINE VERDE	7897832840811	335 x 20 x 235	0		7897832840828	345 x 280 x 165	0	4	7	4202.12.10
0255.U.0050	PASTA ABA ELAS. OFICIO LOMBO 2CM LINE VERMELHA	7897832840859	335 x 20 x 235	0		7897832840866	345 x 280 x 165	0	4	7	4202.12.10
0256.C.0050	PASTA ABA ELAS. OFICIO LOMBO 3CM LINE AZUL	7897832840934	335 x 30 x 235	0		7897832840941	350 x 295 x 215	0	5	7	4202.12.10
0256.H.0050	PASTA ABA ELAS. OFICIO LOMBO 3CM LINE CRISTAL	7897832840972	335 x 30 x 235	0		7897832840989	350 x 295 x 215	0	5	7	4202.12.10
0256.I.0050	PASTA ABA ELAS. OFICIO LOMBO 3CM LINE FUME	7897832841030	335 x 30 x 235	0		7897832841047	350 x 295 x 215	0	5	7	4202.12.10
0256.S.0050	PASTA ABA ELAS. OFICIO LOMBO 3CM LINE SORTIDA	7897832852487	335 x 30 x 235	0		7897832852494	350 x 295 x 215	0	5	7	4202.12.10
0257.A.0050	PASTA ABA ELAS. OFICIO LOMBO 4CM LINE AMARELA	7897832841153	335 x 40 x 235	0		7897832841160	350 x 295 x 215	0	5	7	4202.12.10
0257.C.0050	PASTA ABA ELAS. OFICIO LOMBO 4CM LINE AZUL	7897832841191	335 x 40 x 235	0		7897832841207	350 x 295 x 215	0	5	7	4202.12.10
0257.H.0050	PASTA ABA ELAS. OFICIO LOMBO 4CM LINE CRISTAL	7897832841238	335 x 40 x 235	0		7897832841245	350 x 295 x 215	0	5	7	4202.12.10
0257.I.0050	PASTA ABA ELAS. OFICIO LOMBO 4CM LINE FUME	7897832841276	335 x 40 x 235	0		7897832841283	350 x 295 x 215	0	5	7	4202.12.10
0257.Q.0050	PASTA ABA ELAS. OFICIO LOMBO 4CM LINE ROSA PINK	7897832845601	335 x 40 x 235	0		7897832845618	350 x 295 x 215	0	5	7	4202.12.10
0257.S.0050	PASTA ABA ELAS. OFICIO LOMBO 4CM LINE SORTIDA	7897832852517	335 x 40 x 235	0		7897832852524	350 x 295 x 215	0	5	7	4202.12.10
0257.T.0050	PASTA ABA ELAS. OFICIO LOMBO 4CM LINE VERDE	7897832841313	335 x 40 x 235	0		7897832841320	350 x 295 x 215	0	5	7	4202.12.10
0257.U.0050	PASTA ABA ELAS. OFICIO LOMBO 4CM LINE VERMELHA	7897832841351	335 x 40 x 235	0		7897832841368	350 x 295 x 215	0	5	7	4202.12.10
0258.C.0050	PASTA ABA ELAS. OFICIO LOMBO 5,5 CM LINE AZUL	7897832846301	335 x 55 x 235	0		7897832846318	350 x 295 x 215	0	6	7	4202.12.10
0258.H.0050	PASTA ABA ELAS. OFICIO LOMBO 5,5 CM LINE CRISTAL	7897832846332	335 x 55 x 235	0		7897832846349	350 x 295 x 215	0	6	7	4202.12.10
0258.I.0050	PASTA ABA ELAS. OFICIO LOMBO 5,5 CM LINE FUME	7897832846363	335 x 55 x 235	0		7897832846370	350 x 295 x 215	0	6	7	4202.12.10
0258.S.0050	PASTA ABA ELAS. OFICIO LOMBO 5,5 CM LINE SORTIDA	7897832852289	335 x 55 x 235	0		7897832852296	350 x 295 x 215	0	6	7	4202.12.10
0266.H.0025	PASTA ABA ELASTICO A3 TOP LINE CRISTAL	7897832857475	437 x 0 x 312	0		7897832857482	515 x 230 x 387	0	4	7	4202.12.10
0267.P.0050	PASTA ABA ELASTICO OFICIO EXECUTIVE PRETA	7897832858304	335 x 0 x 235	0		7897832858311	370 x 268 x 202	0	4	7	4202.12.10
0267.S.0050	PASTA ABA ELASTICO OFICIO EXECUTIVE SORTIDA	7897832858335	335 x 0 x 235	0		7897832858342	365 x 245 x 210	0	5	7	4202.12.10
0267.W.0050	PASTA ABA ELASTICO OFICIO EXECUTIVE ROSA	7897832860048	335 x 0 x 235	0		7897832860055	370 x 268 x 202	0	4	7	4202.12.10
0268.P.0050	PASTA ABA ELASTICO OFICIO LB 2CM EXECUTIVE PRETA	7897832858397	335 x 20 x 235	0		7897832858403	370 x 270 x 205	0	6	7	4202.12.10
0269.P.0050	PASTA ABA ELASTICO OFICIO LB 4CM EXECUTIVE PRETA	7897832858489	335 x 40 x 235	0		7897832858496	354 x 292 x 210	0	7	7	4202.12.10
0270.A.0100	PASTA L A4 DELLOPLAST AMARELA - PCT C/10 UN	7897832839433	310 x 0 x 220	0	0	7897832839440	355 x 250 x 55	0	2	7	4202.12.10
0270.BP.0100	PASTA L A4 SERENA AZUL PASTEL - PCT C/10 UN.	7897832870436	310 x 0 x 220	0	0	7897832870443	355 x 250 x 55	0	2	7	4202.12.10
0270.C.0100	PASTA L A4 DELLOPLAST AZUL - PCT C/10 UN.	7897832831475	310 x 0 x 220	0	0	7897832831499	355 x 250 x 55	0	2	7	4202.12.10
0270.H.0100	PASTA L A4 DELLOPLAST CRISTAL - PCT C/10 UN.	7897832831154	310 x 0 x 220	0	0	7897832831178	355 x 250 x 55	0	2	7	4202.12.10
0270.I.0100	PASTA L A4 DELLOPLAST FUME - PCT C/10 UN.	7897832831444	310 x 0 x 220	0	0	7897832831468	355 x 250 x 55	0	2	7	4202.12.10
0270.LP.0100	PASTA L A4 SERENA LILAS PASTEL - PCT C/10 UN.	7897832870467	310 x 0 x 220	0	0	7897832870474	355 x 250 x 55	0	2	7	4202.12.10
0270.S.0100	PASTA L A4 DELLOPLAST SORTIDA PCT C/10UN	7897832854191	310 x 0 x 220	0	0	7897832843614	355 x 250 x 55	0	2	7	4202.12.10
0270.SS.0100	PASTA L A4 SERENA SORTIDA - PCT C/10 UN.	7897832870528	310 x 0 x 220	0	0	7897832870535	355 x 250 x 55	0	0	7	4202.12.10
0270.T.0100	PASTA L A4 DELLOPLAST VERDE - PCT C/10 UN	7897832839471	310 x 0 x 220	0	0	7897832839488	355 x 250 x 55	0	2	7	4202.12.10
0270.U.0100	PASTA L A4 DELLOPLAST VERMELHA - PCT C/10 UN	7897832839518	310 x 0 x 220	0	0	7897832839525	355 x 250 x 55	0	2	7	4202.12.10

CÓDIGO	NOME	EAN13	MEDIDAS	ESPESSURA	GRAMATURA	EAN13 MASTER	MEDIDAS CAIXA	CUBAGEM	PESO TOTAL	IP1	NCM
0270.VP.0100	PASTA L A4 SERENA VERDE PASTEL - PCT C/10 UN.	7897832870559	310 x 0 x 220	0	0	7897832870566	355 x 250 x 55	0	2	7	4202.12.10
0270.WP.0100	PASTA L A4 SERENA ROSA PASTEL - PCT C/10 UN.	7897832870498	310 x 0 x 220	0	0	7897832870504	355 x 250 x 55	0	2	7	4202.12.10
0271.A.0100	PASTA L OFICIO DELLOPLAST AMARELA - PCT C/10 UN	7897832839563	335 x 0 x 225	0	0	7897832839570	380 x 247 x 58	0	3	7	4202.12.10
0271.C.0100	PASTA L OFICIO DELLOPLAST AZUL - PCT C/10 U	7897832831505	335 x 0 x 225	0	0	7897832831529	380 x 247 x 58	0	3	7	4202.12.10
0271.H.0100	PASTA L OFICIO DELLOPLAST CRISTAL - PCT C/10 U	7897832831185	335 x 0 x 225	0	0	7897832831208	380 x 247 x 58	0	3	7	4202.12.10
0271.I.0100	PASTA L OFICIO DELLOPLAST FUME - PCT C/10 U	7897832831536	335 x 0 x 225	0	0	7897832831550	380 x 247 x 58	0	3	7	4202.12.10
0271.S.0100	PASTA L OFICIO DELLOPLAST SORTIDA PCT C/10 UN	7897832843638	335 x 0 x 225	0	0	7897832843638	380 x 247 x 58	0	3	7	4202.12.10
0271.T.0100	PASTA L OFICIO DELLOPLAST VERDE - PCT C/10 UN	7897832839600	335 x 0 x 225	0	0	7897832839617	380 x 247 x 58	0	3	7	4202.12.10
0271.U.0100	PASTA L OFICIO DELLOPLAST VERMELHA PCT C/10 UN	7897832839648	335 x 0 x 225	0	0	7897832839655	380 x 247 x 58	0	3	7	4202.12.10
0272.01.0030	PASTA ABA ELASTICO A4 PANDA ROSA	7897832889896	310 x 0 x 220	0	0	7897832889902	355 x 260 x 118	0	3	7	4202.12.10
0272.02.0030	PASTA ABA ELASTICO A4 PANDA VERDE	7897832889919	310 x 0 x 220	0	0	7897832889926	355 x 260 x 118	0	3	7	4202.12.10
0274.P.0030	PASTA ABA ELASTICO OFICIO SECRETS PRETA	7897832869553	335 x 0 x 235	0	0	7897832869560	262 x 250 x 150	0	3	7	4202.12.10
0274.S.0030	PASTA ABA ELASTICO OFICIO SECRETS SORTIDA	7897832870276	335 x 0 x 235	0	0	7897832870283	262 x 250 x 150	0	3	7	4202.12.10
0274.W.0030	PASTA ABA ELASTICO OFICIO SECRETS ROSA	7897832869591	335 x 0 x 235	0	0	7897832869607	262 x 250 x 150	0	3	7	4202.12.10
0275.P.0030	PASTA ABA ELASTICO OFICIO LB 2CM SECRETS PRETA	7897832869676	335 x 20 x 235	0	0	7897832869683	345 x 280 x 165	0	3	7	4202.12.10
0275.S.0030	PASTA ABA ELASTICO OFICIO LB 2CM SECRETS SORTIDA	7897832870313	335 x 20 x 235	0	0	7897832870320	345 x 280 x 165	0	3	7	4202.12.10
0275.W.0030	PASTA ABA ELASTICO OFICIO LB 2CM SECRETS ROSA	7897832869713	335 x 20 x 235	0	0	7897832869720	345 x 280 x 165	0	3	7	4202.12.10
0277.BP.0050	PASTA ABA ELASTICO 1/2 OFICIO LINHO SERENA AZUL PASTEL	7897832871440	245 x 0 x 180	0	0	7897832871457	255 x 215 x 195	0	2	7	4202.12.10
0277.LP.0050	PASTA ABA ELASTICO 1/2 OFICIO LINHO SERENA LILAS PASTEL	7897832871471	245 x 0 x 180	0	0	7897832871488	255 x 215 x 195	0	2	7	4202.12.10
0277.SS.0050	PASTA ABA ELASTICO 1/2 OFICIO LINHO SERENA SORTIDA	7897832872317	245 x 0 x 180	0	0	7897832872324	255 x 215 x 195	0	2	7	4202.12.10
0277.VP.0050	PASTA ABA ELASTICO 1/2 OFICIO LINHO SERENA VERDE PASTEL	7897832871532	245 x 0 x 180	0	0	7897832871549	255 x 215 x 195	0	2	7	4202.12.10
0277.WP.0050	PASTA ABA ELASTICO 1/2 OFICIO LINHO SERENA ROSA PASTEL	7897832871501	245 x 0 x 180	0	0	7897832871518	255 x 215 x 195	0	2	7	4202.12.10
0278.BP.0050	PASTA ABA ELASTICO 1/2 OF. LB2,5 LINHO SERENA AZUL PASTE	7897832871563	245 x 25 x 180	0	0	7897832871570	255 x 215 x 195	0	2	7	4202.12.10
0278.LP.0050	PASTA ABA ELASTICO 1/2 OF. LB2,5 LINHO SERENA LILAS PASTE	7897832871594	245 x 25 x 180	0	0	7897832871600	255 x 215 x 195	0	2	7	4202.12.10
0278.SS.0050	PASTA ABA ELASTICO 1/2 OF. LB2,5 LINHO SERENA SORTIDA	7897832872379	245 x 25 x 180	0	0	7897832872386	255 x 215 x 195	0	2	7	4202.12.10
0278.VP.0050	PASTA ABA ELASTICO 1/2 OF. LB2,5 LINHO SERENA VERDE PASTEL	7897832871624	245 x 25 x 180	0	0	7897832871631	255 x 215 x 195	0	2	7	4202.12.10
0278.WP.0050	PASTA ABA ELASTICO 1/2 OF. LB2,5 LINHO SERENA ROSA PASTEL	7897832871655	245 x 25 x 180	0	0	7897832871662	255 x 215 x 195	0	24	7	4202.12.10
0282.P.0050	PASTA ABA ELASTICO 1/2 OFICIO EXECUTIVE PRETA	7897832872447	245 x 0 x 180	0	0	7897832872454	255 x 215 x 195	0	2	7	4202.12.10
0290.A.0050.2	PASTA GRAMPO DELLOPLUS AM.C/GP	7897832807623	343 x 0 x 236	0	250 a 280g/m²	7897832807616	365 x 255 x 190	0	3	10	4820.90.00
0290.C.0050.2	PASTA GRAMPO DELLOPLUS AZ.C/GP	7897832807562	343 x 0 x 236	0	250 a 280g/m²	7897832807555	365 x 255 x 190	0	3	10	4820.90.00
0290.P.0050.2	PASTA GRAMPO DELLOPLUS PT.C/GP	7897832807715	343 x 0 x 236	0	250 a 280g/m²	7897832807708	365 x 255 x 190	0	3	10	4820.90.00
0290.T.0050.2	PASTA GRAMPO DELLOPLUS VD.C/GP	7897832807654	343 x 0 x 236	0	250 a 280g/m²	7897832807647	365 x 255 x 190	0	3	10	4820.90.00
0291.A.0050.2	PASTA GRAMPO DELLOPLAST AMARELA C/GP - PCT C/10 UN	7897832804554	340 x 0 x 245	0	0	7897832804561	350 x 292 x 140	0	3	7	4202.12.10
0291.C.0050.2	PASTA GRAMPO DELLOPLAST AZUL.C/GP - PCT C/10 UN	7897832804578	340 x 0 x 245	0	0	7897832804585	350 x 292 x 140	0	3	7	4202.12.10
0291.H.0050.2	PASTA GRAMPO DELLOPLAST CRISTAL.C/GP - PCT C/10 UN	7897832804592	340 x 0 x 245	0	0	7897832804608	350 x 292 x 140	0	3	7	4202.12.10
0291.I.0050.2	PASTA GRAMPO ESCOLAR DELLOPLAST FUME C/ GP	7897832804615	340 x 0 x 245	0	0	7897832804622	350 x 292 x 140	0	3	7	4202.12.10
0291.Q.0050.2	PASTA GRAMPO ESCOLAR DELLOPLAST ROSA C/ GP - PCT C/10 UN	7897832804639	340 x 0 x 245	0	0	7897832804646	350 x 292 x 140	0	3	7	4202.12.10
0291.S.0050.2	PASTA GRAMPO ESCOLAR DELLOPLAST SORTIDA C/ GP - PCT C/10 UN	7897832849395	340 x 0 x 245	0	0	7897832819862	350 x 292 x 140	0	3	7	4202.12.10
0291.T.0050.2	PASTA GRAMPO ESCOLAR DELLOPLAST VERDE C/ GP - PCT C/10 UN	7897832804653	340 x 0 x 245	0	0	7897832804660	350 x 292 x 140	0	3	7	4202.12.10
0291.U.0050.2	PASTA GRAMPO ESCOLAR DELLOPLAST VERMELHA C/ GP - PCT C/10 UN	7897832818551	340 x 0 x 245	0	0	7897832818568	350 x 292 x 140	0	3	7	4202.12.10
0292.A.0050.2	PASTA GRAMPO DELLOPLEX AM.C/GP	7897832805360	343 x 0 x 236	0	250 a 270g/m²	7897832805353	365 x 255 x 190	0	3	10	4820.90.00
0292.C.0050.2	PASTA GRAMPO DELLOPLEX AZ.C/GP	7897832805384	343 x 0 x 236	0	250 a 270g/m²	7897832805377	365 x 255 x 190	0	3	10	4820.90.00
0292.E.0050.2	PASTA GRAMPO DELLOPLEX BR.C/GP	7897832805407	343 x 0 x 236	0	250 a 270g/m²	7897832805391	365 x 255 x 190	0	3	10	4820.90.00
0292.P.0050.2	PASTA GRAMPO DELLOPLEX PT.C/GP	7897832805421	343 x 0 x 236	0	250 a 270g/m²	7897832805414	365 x 255 x 190	0	3	10	4820.90.00
0292.S.0050.2	PASTA GRAMPO DELLOPLEX SR.C/GP	7897832849401	343 x 0 x 236	0	250 a 270g/m²	7897832832489	365 x 255 x 190	0	3	10	4820.90.00
0292.U.0050.2	PASTA GRAMPO DELLOPLEX VM.C/GP	7897832805445	343 x 0 x 236	0	250 a 270g/m²	7897832805438	365 x 255 x 190	0	3	10	4820.90.00
0294.P.0050.2	PASTA GRAMPO OFICIO EXECUTIVE PRETA C/ GP - PCT C/10 UN	7897832858601	335 x 0 x 245	0	0	7897832858618	350 x 292 x 140	0	5	7	4202.12.10
0295.BP.0050.2	PASTA GRAMPO OF. LINHO SERENA AZUL PASTEL C/GP - PCT C/10	7897832863049	335 x 0 x 245	0	0	7897832863056	350 x 292 x 140	0	4	7	4202.12.10
0295.LP.0050.2	PASTA GRAMPO OF. LINHO SERENA LILAS PASTEL C/GP - PCT C/10	7897832863070	335 x 0 x 245	0	0	7897832863087	350 x 292 x 140	0	4	7	4202.12.10
0295.S.0050.2	PASTA GRAMPO OFICIO LINHO SERENA SORTIDA C/GP - PCT C/10	7897832863773	335 x 0 x 245	0	0	7897832863780	350 x 292 x 140	0	4	7	4202.12.10
0295.WP.0050.2	PASTA GRAMPO OF. LINHO SERENA ROSA PASTEL C/GP - PCT C/10	7897832863131	335 x 0 x 245	0	0	7897832863148	350 x 292 x 140	0	4	7	4202.12.10
0296.C.0050.2	PASTA GRAMPO FULL COLOR AZUL C/ GP - PCT C/ 10	7897832890427	335 x 0 x 245	0	0	7897832890434	350 x 292 x 140	0	4	7	4202.12.10
0296.Q.0050.2	PASTA GRAMPO FULL COLOR PINK C/ GP - PCT C/ 10	7897832890441	335 x 0 x 245	0	0	7897832890458	350 x 292 x 140	0	4	7	4202.12.10
0296.R.0050.2	PASTA GRAMPO FULL COLOR ROXA C/ GP - PCT C/ 10	7897832890465	335 x 0 x 245	0	0	7897832890472	350 x 292 x 140	0	4	7	4202.12.10
0297.H.0050.2	PASTA GRAMPO A4 LINE CRISTAL C/ GP - PCT C/ 10	7897832894159	340 x 0 x 245	0	0	7897832894166	350 x 292 x 140	0	3	7	4202.12.10
0297.I.0050.2	PASTA GRAMPO A4 LINE FUME C/ GP - PCT C/ 10	7897832894180	340 x 0 x 245	0	0	7897832894197	350 x 292 x 140	0	3	7	4202.12.10
0299.E.0010.2	GRAMPO PLAST. ESTENDIDO DELLOFIX BC.PCT.C/50UN.	7897832821322	305 x 163 x 25	3	3g	7897832821339	375 x 273 x 105	0	2	10	3926.10.00
0300.O.0020.1	GRAMPO TRILHO DELLOFIX CX.C/50UN.	7897832800181	140 x 20 x 70	0	5,2g	7897832800228	320 x 150 x 165	0	4	0	8308.10.00
0301.E.0020.2	GRAMPO PLAST.DELLOFIX BC.PCT.C/50UN.	7897832805223	205 x 153 x 25	3	1,4g	7897832803441	270 x 265 x 220	0	3	10	3926.10.00
0301.P.0020.2	GRAMPO PLAST.DELLOFIX PT.PCT.C/50UN.	7897832818957	205 x 153 x 25	3	1,4g	7897832818964	270 x 265 x 220	0	3	10	3926.10.00
0302.O.0010	GRAMPO U DELLOFIX	7897832800402	130 x 40 x 100	2	2,7g	7897832801867	350 x 260 x 80	0	2	3	7616.99.00
0306.X.0025	CAIXA P/ ARQUIVO MORTO - OFICIO	7897832802581	365 x 143 x 256	3	420g/m²	7897832800525	900 x 685 x 100	0	6	0	4819.10.00
0308.X.0025	CAIXA P/ ARQUIVO MORTO - GIGANTE	7897832802598	412 x 185 x 309	3	410g/m²	7897832800631	1110 x 830 x 100	0	9	0	4819.10.00
0314.E.0010	KIT ARAMADO DELLO SEM PASTAS	7897832810722	400 x 140 x 280	0	0	7897832810739	555 x 415 x 110	0	5	0	7314.39.00
0317.H.0005	MALETA DELLOPLAST CRISTAL MONTADA C/ 10 PASTAS SUSP. DELOPLU	7897832802963	390 x 140 x 260	0	0	7897832819961	730 x 412 x 290	0	7	7	4202.12.10

CÓDIGO	NOME	EAN13	MEDIDAS	ESPESSURA	GRAMATURA	EAN13 MASTER	MEDIDAS CAIXA	CUBAGEM	PESO TOTAL	IP1	NCM
0317.H.0005X	MALETA DELLOPLAST CRISTAL C/ PASTAS SUSP.KRAFT	7897832828871	390 x 140 x 260	0		7897832828888	730 x 412 x 290	0	7	7	4202.12.10
0317.I.0005	MALETA DELLOPLAST FUME MONTADA C/ 10 PASTAS SUSP. DELLOPLUS	7897832802970	390 x 140 x 260	0		7897832819978	730 x 412 x 290	0	7	7	4202.12.10
0317.L.0005X	MALETA DELLOPLAST FUME MONTADA C/10 PASTAS SUSP. KRAFT	7897832828895	390 x 140 x 260	0		7897832828901	730 x 412 x 290	0	7	7	4202.12.10
0318.H.0005	MALETA DELLOPLAST CRISTAL S/ PASTAS	7897832810647	390 x 140 x 262	0		7897832810654	436 x 408 x 170	0	2	7	4202.12.10
0318.I.0005	MALETA DELLOPLAST FUME S/ PASTAS	7897832810661	390 x 140 x 262	0		7897832810678	436 x 408 x 170	0	2	7	4202.12.10
0319.H.0005	MALETA DELLOPLAST CR.MONT.C/10PTS.COL.	7897832810586	390 x 140 x 262	0		7897832810593	730 x 412 x 290	0	7	7	4202.12.10
0319.I.0005	MALETA DELLOPLAST FM.MONT.C/10 PTS.COL.	7897832814805	390 x 140 x 262	0		7897832814812	730 x 412 x 290	0	7	7	4202.12.10
0320.H.0003	ORGANIZADOR DELLOCOLOR CRISTAL C/06 PTS SUSP BRANCAS	7897832818636	425 x 148 x 270			7897832818643	465 x 465 x 310	0	4	10	3926.10.00
0321.H.0003	ORGANIZADOR DELLOCOLOR CR.C/06 PTS COL.	7897832818698	425 x 148 x 270			7897832818704	465 x 465 x 310	0	4	10	3926.10.00
0322.H.0003	ORGANIZADOR DELLOCOLOR CRISTAL .C/06 PTS SUSP. KRAFT	7897832819886	425 x 148 x 270			7897832819893	465 x 465 x 310	0	5	10	3926.10.00
0326.A.0025	CAIXA ARQUIVO MORTO POLIDELLO OFICIO AMARELO	7897832850193	350 x 135 x 250	2	300g/m2	7897832850209	860 x 660 x 50	0	3	10	3923.10.90
0326.C.0025	CAIXA ARQUIVO MORTO POLIDELLO OFICIO AZUL	7897832850216	350 x 135 x 250	2	300g/m2	7897832850223	860 x 660 x 50	0	3	10	3923.10.90
0326.E.0025	CAIXA ARQUIVO MORTO POLIDELLO OFICIO BRANCO	7897832850230	350 x 135 x 248	2	300g/m2	7897832850247	860 x 660 x 50	0	3	10	3923.10.90
0326.G.0025	CAIXA ARQUIVO MORTO POLIDELLO OFICIO CINZA	7897832850254	350 x 135 x 248	2	300g/m2	7897832850261	860 x 660 x 50	0	3	10	3923.10.90
0326.P.0025	CAIXA ARQUIVO MORTO POLIDELLO OFICIO PRETO	7897832850278	350 x 135 x 248	2	300g/m2	7897832850285	860 x 660 x 50	0	3	10	3923.10.90
0326.T.0025	CAIXA ARQUIVO MORTO POLIDELLO OFICIO VERDE	7897832850292	350 x 135 x 248	2	300g/m2	7897832850308	860 x 660 x 50	0	3	10	3923.10.90
0326.U.0025	CAIXA ARQUIVO MORTO POLIDELLO OFICIO VERMELHO	7897832850315	350 x 135 x 248	2	300g/m2	7897832850322	860 x 660 x 50	0	3	10	3923.10.90
0327.A.0025	CAIXA ARQUIVO MORTO POLIDELLO GIGANTE AMARELO	7897832850339	395 x 185 x 300		300g/m2	7897832850346	1100 x 830 x 60	0	5	10	3923.10.90
0327.C.0025	CAIXA ARQUIVO MORTO POLIDELLO GIGANTE AZUL	7897832850353	395 x 185 x 300		300g/m2	7897832850360	1100 x 830 x 60	0	5	10	3923.10.90
0327.G.0025	CAIXA ARQUIVO MORTO POLIDELLO GIGANTE CINZA	7897832850391	395 x 185 x 300		300g/m2	7897832850407	1100 x 830 x 60	0	5	10	3923.10.90
0327.P.0010.BR	CAIXA ARQUIVO MORTO POLIDELLO GIGANTE PRETO PCT 10	7897832883627	1020 x 470 x 60		300g/m2	7897832883627	1020 x 470 x 60	0	2	10	3923.10.90
0327.T.0010.BR	CAIXA ARQUIVO MORTO POLIDELLO GIGANTE VERDE PCT 10	7897832882507	1020 x 470 x 60		300g/m2	7897832882507	1020 x 470 x 60	0	2	10	3923.10.90
0327.U.0010.BR	CAIXA ARQUIVO MORTO POLIDELLO GIGANTE VERMELHO PCT 10	7897832882514	1020 x 470 x 60		300g/m2	7897832882514	1020 x 470 x 60	0	2	10	3923.10.90
0328.H.0005	CAIXA ARQUIVO DELLOCOLOR CRISTAL C/ 6 PASTAS SUSP COLORIDAS	7897832857857	440 x 175 x 270	2		7897832857864	890 x 440 x 285	0	6	10	3926.10.00
0329.B.0005	CAIXA ARQUIVO DELLOCOLOR AZUL CLARO S/ PASTA SUSPENSAS	7897832859967	440 x 175 x 270	2		7897832859974	445 x 195 x 525	0	3	7	3924.90.00
0329.H.0005	CAIXA ARQUIVO DELLOCOLOR CRISTAL SEM PASTA SUSPENSAS	7897832853644	440 x 175 x 270	2		7897832853651	445 x 195 x 525	0	3	7	3924.90.00
0329.P.0005	CAIXA ARQUIVO DELLOCOLOR PRETA SEM PASTA SUSPENSAS	7897832851602	440 x 175 x 270	2		7897832851619	445 x 195 x 525	0	3	7	3924.90.00
0329.W.0005	CAIXA ARQUIVO DELLOCOLOR ROSA SEM PASTA SUSPENSAS	7897832860024	440 x 175 x 270	2		7897832860031	445 x 195 x 525	0	3	7	3924.90.00
0330.P.0005	CAIXA ARQUIVO DELLOCOLOR PRETA C/6 PASTAS SUSP. KRAFT	7897832851725	440 x 175 x 270	2		7897832851732	890 x 440 x 285	0	5	10	3926.10.00
0331.C.0003	MALETA ORGANIZADORA EMPILHABEL AZUL	7897832851800	460 x 210 x 270			7897832851817	640 x 470 x 290	0	3	7	3924.90.00
0331.H.0003	MALETA ORGANIZADORA EMPILHABEL CRISTAL	7897832851824	460 x 210 x 270			7897832851831	640 x 470 x 290	0	3	7	3924.90.00
0331.P.0003	MALETA ORGANIZADORA EMPILHABEL PRETA	7897832851848	460 x 210 x 270	1		7897832851855	640 x 470 x 290	0	3	7	3924.90.00
0332.H.0003	MALETA ARQUIVO EMPILHABEL CRISTAL C/6 PASTAS SUSP. KRAFT	7897832851947	460 x 210 x 270			7897832851954	640 x 470 x 290	0	4	10	3926.10.00
0332.P.0003	MALETA ARQUIVO EMPILHABEL PRETA C/6 PASTAS SUSP. KRAFT	7897832851961	460 x 210 x 270			7897832851978	640 x 470 x 290	0	4	10	3926.10.00
0335.H.0005	CAIXA MULTIUSO LARGA CRISTAL	7897832871761	435 x 290 x 270			7897832871778	446 x 310 x 620	0	5	7	3924.90.00
0335.P.0005	CAIXA MULTIUSO LARGA PRETA	7897832871785	435 x 290 x 270			7897832871792	446 x 310 x 620	0	5	7	3924.90.00
0438.C.0030	PASTA ABA ELASTICO A4 LOMBO 2 CM FULL COLOR AZUL	7897832890861	310 x 20 x 220	0		7897832890878	345 x 280 x 165	0	3	7	4202.12.10
0438.Q.0030	PASTA ABA ELASTICO A4 LOMBO 2 CM FULL COLOR PINK	7897832890885	310 x 20 x 220	0		7897832890892	345 x 280 x 165	0	3	7	4202.12.10
0438.R.0030	PASTA ABA ELASTICO A4 LOMBO 2 CM FULL COLOR ROXA	7897832890908	310 x 20 x 220	0		7897832890915	345 x 280 x 165	0	3	7	4202.12.10
0439.C.0030	PASTA ABA ELASTICO A4 LOMBO 4 CM FULL COLOR AZUL	7897832890922	310 x 40 x 220	0		7897832890939	350 x 295 x 215	0	3	7	4202.12.10
0439.Q.0030	PASTA ABA ELASTICO A4 LOMBO 4 CM FULL COLOR PINK	7897832890946	310 x 40 x 220	0		7897832890953	350 x 295 x 215	0	3	7	4202.12.10
0439.R.0030	PASTA ABA ELASTICO A4 LOMBO 4 CM FULL COLOR ROXA	7897832890960	310 x 40 x 220	0		7897832890977	350 x 295 x 215	0	3	7	4202.12.10
0440.C.0050	PASTA ABA ELASTICO 1/2 OFICIO FULL COLOR AZUL	7897832888028	245 x 0 x 180	0		7897832888035	255 x 215 x 195	0	2	7	4202.12.10
0440.K.0050	PASTA ABA ELASTICO 1/2 OFICIO FULL COLOR LARANJA	7897832888042	245 x 0 x 180	0		7897832888059	255 x 215 x 195	0	2	7	4202.12.10
0440.Q.0050	PASTA ABA ELASTICO 1/2 OFICIO FULL COLOR PINK	7897832888066	245 x 0 x 180	0		7897832888073	255 x 215 x 195	0	2	7	4202.12.10
0440.R.0050	PASTA ABA ELASTICO 1/2 OFICIO FULL COLOR ROXA	7897832888080	245 x 0 x 180	0		7897832888097	255 x 215 x 195	0	2	7	4202.12.10
0440.S.0050	PASTA ABA ELASTICO 1/2 OFICIO FULL COLOR SORTIDA	7897832888438	245 x 0 x 180	0		7897832888445	255 x 215 x 195	0	2	7	4202.12.10
0440.VL.0050	PASTA ABA ELASTICO 1/2 OFICIO FULL COLOR VERDE LIMAO	7897832888004	245 x 0 x 180	0		7897832888011	255 x 215 x 195	0	2	7	4202.12.10
0442.C.0030	PASTA ABA ELASTICO A4 FULL COLOR AZUL	7897832888127	310 x 0 x 220	0		7897832888134	355 x 260 x 118	0	3	7	4202.12.10
0442.K.0030	PASTA ABA ELASTICO A4 FULL COLOR LARANJA	7897832888141	310 x 0 x 220	0		7897832888158	355 x 260 x 118	0	3	7	4202.12.10
0442.Q.0030	PASTA ABA ELASTICO A4 FULL COLOR PINK	7897832888165	310 x 0 x 220	0		7897832888172	355 x 260 x 118	0	3	7	4202.12.10
0442.R.0030	PASTA ABA ELASTICO A4 FULL COLOR ROXA	7897832888189	310 x 0 x 220	0		7897832888196	355 x 260 x 118	0	3	7	4202.12.10
0442.S.0030	PASTA ABA ELASTICO A4 FULL COLOR SORTIDA	7897832888414	310 x 0 x 220	0		7897832888421	355 x 260 x 118	0	3	7	4202.12.10
0442.VL.0030	PASTA ABA ELASTICO A4 FULL COLOR VERDE LIMAO	7897832888103	310 x 0 x 220	0		7897832888110	355 x 260 x 118	0	3	7	4202.12.10
0443.H.0030	PASTA ABA ELASTICO OFICIO TOP LINE PEROLIZADA CRISTAL	7897832889704	335 x 0 x 235	0		7897832889711	349 x 251 x 250	0	3	7	4202.12.10
0443.LP.0030	PASTA ABA ELASTICO OFICIO TOP LINE PEROLIZADA LILAS	7897832889728	335 x 0 x 235	0		7897832889735	349 x 251 x 250	0	3	7	4202.12.10
0443.WP.0030	PASTA ABA ELASTICO OFICIO TOP LINE PEROLIZADA ROSA	7897832889742	335 x 0 x 235	0		7897832889759	349 x 251 x 250	0	3	7	4202.12.10
0446.H.0030	PASTA ABA ELASTICO OF. LB 4CM TOP LINE PEROLIZADA CRISTAL	7897832889766	335 x 40 x 235	0		7897832889773	430 x 305 x 350	0	5	7	4202.12.10
0446.LP.0030	PASTA ABA ELASTICO OF. LB 4CM TOP LINE PEROLIZADA LILAS	7897832889780	335 x 40 x 235	0		7897832889797	430 x 305 x 350	0	5	7	4202.12.10
0446.WP.0030	PASTA ABA ELASTICO OF. LB 4CM TOP LINE PEROLIZADA ROSA	7897832889803	335 x 40 x 235	0		7897832889810	430 x 305 x 350	0	5	7	4202.12.10
0450.C.0050	PASTA ABA ELASTICO A4 LINE AZUL	7897832893732	310 x 0 x 220	0		7897832893749	345 x 240 x 160	0	3	7	4202.12.10
0450.H.0050	PASTA ABA ELASTICO A4 LINE CRISTAL	7897832893756	310 x 0 x 220	0		7897832893763	345 x 240 x 160	0	3	7	4202.12.10
0450.I.0050	PASTA ABA ELASTICO A4 LINE FUME	7897832893770	310 x 0 x 220	0		7897832893787	345 x 240 x 160	0	3	7	4202.12.10
0532.H.0012	QUADRO DE AVISOS OFICIO CRISTAL	7897832854955	333 x 5 x 220	0		7897832854962	360 x 237 x 90	0	1	10	3926.10.00
0533.H.0012	QUADRO DE AVISOS A3 CRISTAL	7897832854979	420 x 5 x 300	0		7897832854986	450 x 317 x 88	0	2	10	3926.10.00

CÓDIGO	NOME	EAN13	MEDIDAS	ESPESSURA	GRAMATURA	EAN13 MASTER	MEDIDAS CAIXA	CUBAGEM	PESO TOTAL	IP1	NCM
0534.H.0012	QUADRO DE AVISOS A4 CRISTAL	7897832854993	300 x 5 x 210	0		7897832855006	325 x 220 x 92	0	1	10	3926.10.00
0535.H.0012	QUADRO DE AVISOS A5 CRISTAL	7897832855013	210 x 5 x 150	0		7897832855020	240 x 165 x 110	0	0	10	3926.10.00
0535.PET.0012	QUADRO DE AVISOS A5 CRISTAL EM PET	7897832890137	210 x 5 x 150	0		7897832890144	240 x 165 x 110	0	0	10	3926.10.00
0538.H.0012	QUADRO DE AVISOS A4 RIGIDO	7897832885683	235 x 5 x 317	2		7897832885690	350 x 260 x 80	0	4	10	3926.10.00
0539.H.0012	QUADRO DE AVISOS A5 RIGIDO	7897832885706	173 x 5 x 230	2		7897832885713	350 x 260 x 80	0	2	10	3926.10.00
0598.X.0050.2	PASTA VETROLATERAL 6001 KRAFTSUP.C/GP	7897832810487	339 x 0 x 255	0	300g/m²	7897832801201	436 x 408 x 170	0	6	10	4820.90.00
0599.X.0050.2	PASTA VETROLATERAL 8001 KRAFTSUP.C/GP	7897832810494	365 x 0 x 258	0	300g/m²	7897832801232	436 x 408 x 170	0	6	10	4820.90.00
0599.X.0050.2PL	PASTA VETROLATERAL 8001 KRAFTSUPER PLASTIFICADA C/GP	7897832890809	365 x 0 x 258	0	300g/m²	7897832890816	436 x 408 x 170	0	6	10	4820.90.00
0700.P.0005	PASTA SANFONADA OFICIO A/Z 1-31	7897832800549	370 x 45 x 260			7897832801584	388 x 270 x 210	0	8	10	4820.90.00
0701.P.0005	PASTA SANFONADA DUPLIC A/Z 1-31	7897832800556	250 x 65 x 190			7897832801577	258 x 248 x 230	0	4	10	4820.90.00
0703.P.0005	PASTA SANFONADA PT.CH. A/Z 1-31	7897832800600	250 x 45 x 130			7897832801560	255 x 215 x 195	0	3	10	4820.90.00
0704.P.0005	PASTA SANFONADA OFICIO C/ 12 DIV.JAN/DEZ	7897832802048	370 x 25 x 260			7897832802055	428 x 298 x 120	0	5	10	4820.90.00
0705.P.0005	PASTA SANFONADA DUPLIC. C/ 12 DIV.JAN/DEZ	7897832802062	250 x 25 x 180			7897832802079	255 x 215 x 195	0	2	10	4820.90.00
0706.P.0005	PASTA SANFONADA PT.CH. C/ 12 DIV.JAN/DEZ	7897832802086	250 x 25 x 130			7897832802093	255 x 215 x 195	0	2	10	4820.90.00
0712.C.0050	PASTA CONTRATO AZUL	7897832808422	325 x 0 x 235	0	180 a 190g/m²	7897832810012	350 x 260 x 80	0	2	10	4820.90.00
0712.E.0050	PASTA CONTRATO BRANCA	7897832819695	325 x 0 x 235	0	180 a 190g/m²	7897832810036	350 x 260 x 80	0	2	10	4820.90.00
0935.H.0050	PASTA CANALETA A4 DELLOPLAST CRISTAL	7897832805285	307 x 0 x 220	0		7897832805278	350 x 260 x 80	0	2	7	4202.12.10
0935.I.0050	PASTA CANALETA A4 DELLOPLAST FUME	7897832805308	307 x 0 x 220	0		7897832805292	350 x 260 x 80	0	2	7	4202.12.10
0961.A.0010	PASTA ABA ELASTICO OFICIO LOMBO 2 CM POLIDELLO AMARELA	7897832881463	340 x 20 x 245		300g/m²	7897832881470	580 x 440 x 20	0	0	7	4202.12.10
0961.C.0010	PASTA ABA ELASTICO OFICIO LOMBO 2 CM POLIDELLO AZUL	7897832881487	340 x 20 x 245		300g/m²	7897832881494	580 x 440 x 20	0	0	7	4202.12.10
0961.H.0010	PASTA ABA ELASTICO OFICIO LOMBO 2 CM POLIDELLO CRISTAL	7897832883917	340 x 20 x 245		300g/m²	7897832883924	580 x 440 x 20	0	0	7	4202.12.10
0961.P.0010	PASTA ABA ELASTICO OFICIO LOMBO 2 CM POLIDELLO PRETA	7897832883658	340 x 20 x 245		300g/m²	7897832883665	580 x 440 x 20	0	0	7	4202.12.10
0961.T.0010	PASTA ABA ELASTICO OFICIO LOMBO 2 CM POLIDELLO VERDE	7897832881500	340 x 20 x 245		300g/m²	7897832881517	580 x 440 x 20	0	0	7	4202.12.10
0961.U.0010	PASTA ABA ELASTICO OFICIO LOMBO 2 CM POLIDELLO VERMELHA	7897832881524	340 x 20 x 245		300g/m²	7897832881531	580 x 440 x 20	0	0	7	4202.12.10
0962.A.0010	PASTA ABA ELASTICO OFICIO LOMBO 3,5 CM POLIDELLO AMARELA	7897832881548	340 x 35 x 245		300g/m²	7897832881555	615 x 480 x 20	0	0	7	4202.12.10
0962.C.0010	PASTA ABA ELASTICO OFICIO LOMBO 3,5 CM POLIDELLO AZUL	7897832881562	340 x 35 x 245		300g/m²	7897832881579	615 x 480 x 20	0	0	7	4202.12.10
0962.H.0010	PASTA ABA ELASTICO OFICIO LOMBO 3,5 CM POLIDELLO CRISTAL	7897832883931	340 x 35 x 245		300g/m²	7897832883948	615 x 480 x 20	0	0	7	4202.12.10
0962.P.0010	PASTA ABA ELASTICO OFICIO LOMBO 3,5 CM POLIDELLO PRETA	7897832883672	340 x 35 x 245		300g/m²	7897832883689	615 x 480 x 20	0	0	7	4202.12.10
0962.T.0010	PASTA ABA ELASTICO OFICIO LOMBO 3,5 CM POLIDELLO VERDE	7897832881586	340 x 35 x 245		300g/m²	7897832881593	615 x 480 x 20	0	0	7	4202.12.10
0962.U.0010	PASTA ABA ELASTICO OFICIO LOMBO 3,5 CM POLIDELLO VERMELHA	7897832881609	340 x 35 x 245		300g/m²	7897832881616	615 x 480 x 20	0	0	7	4202.12.10
0963.A.0010	PASTA ABA ELASTICO OFICIO LOMBO 5,5 CM POLIDELLO AMARELA	7897832881623	340 x 55 x 245		300g/m²	7897832881630	652 x 535 x 20	0	0	7	4202.12.10
0963.C.0010	PASTA ABA ELASTICO OFICIO LOMBO 5,5 CM POLIDELLO AZUL	7897832881647	340 x 55 x 245		300g/m²	7897832881654	652 x 535 x 20	0	0	7	4202.12.10
0963.H.0010	PASTA ABA ELASTICO OFICIO LOMBO 5,5 CM POLIDELLO CRISTAL	7897832883955	340 x 55 x 245		300g/m²	7897832883962	652 x 535 x 20	0	0	7	4202.12.10
0963.P.0010	PASTA ABA ELASTICO OFICIO LOMBO 5,5 CM POLIDELLO PRETA	7897832883696	340 x 55 x 245		300g/m²	7897832883702	652 x 535 x 20	0	0	7	4202.12.10
0963.T.0010	PASTA ABA ELASTICO OFICIO LOMBO 5,5 CM POLIDELLO VERDE	7897832881760	340 x 55 x 245		300g/m²	7897832881777	652 x 535 x 20	0	0	7	4202.12.10
0963.U.0010	PASTA ABA ELASTICO OFICIO LOMBO 5,5 CM POLIDELLO VERMELHA	7897832881661	340 x 55 x 245		300g/m²	7897832881678	652 x 535 x 20	0	0	7	4202.12.10
0970.A.0005	MALETA OFICIO POLIDELLO AMARELA	7897832881685	385 x 45 x 285		300g/m²	7897832881692	400 x 275 x 300	0	1	7	4202.12.10
0970.C.0005	MALETA OFICIO POLIDELLO AZUL	7897832881708	385 x 45 x 285		300g/m²	7897832881715	400 x 275 x 300	0	1	7	4202.12.10
0970.H.0005	MALETA OFICIO POLIDELLO CRISTAL	7897832883979	385 x 45 x 285		300g/m²	7897832883986	400 x 275 x 300	0	1	7	4202.12.10
0970.T.0005	MALETA OFICIO POLIDELLO VERDE	7897832881722	385 x 45 x 285		300g/m²	7897832881739	400 x 275 x 300	0	1	7	4202.12.10
0970.U.0005	MALETA OFICIO POLIDELLO VERMELHA	7897832881746	385 x 45 x 285		300g/m²	7897832881753	400 x 275 x 300	0	1	7	4202.12.10
0971.C.0005	MALETA A3 POLIDELLO AZUL	7897832883719	505 x 40 x 357	1	300g/m²	7897832883726	515 x 230 x 387	0	1	7	4202.12.10
0971.H.0005	MALETA A3 POLIDELLO CRISTAL	7897832883993	505 x 40 x 357	1	300g/m²	7897832884006	515 x 230 x 387	0	1	7	4202.12.10
0971.P.0005	MALETA A3 POLIDELLO PRETA	7897832883733	505 x 40 x 357	1	300g/m²	7897832883740	515 x 230 x 387	0	1	7	4202.12.10
0971.T.0005	MALETA A3 POLIDELLO VERDE	7897832883757	505 x 40 x 357	1	300g/m²	7897832883764	515 x 230 x 387	0	1	7	4202.12.10
0971.U.0005	MALETA A3 POLIDELLO VERMELHA	7897832883771	505 x 40 x 357	1	300g/m²	7897832883788	515 x 230 x 387	0	1	7	4202.12.10
2151.C.0005	MALETA A3 DELLOFINE AZUL	7897832833325	505 x 32 x 353	1		7897832833332	515 x 230 x 387	0	2	7	4202.12.10
2151.H.0005	MALETA A3 DELLOFINE CRISTAL	7897832833349	505 x 32 x 353	1		7897832833356	515 x 230 x 387	0	2	7	4202.12.10
2151.I.0005	MALETA A3 DELLOFINE FUME	7897832833363	505 x 32 x 353	1		7897832833370	515 x 230 x 387	0	2	7	4202.12.10
2151.P.0005	MALETA A3 DELLOFINE PRETA	7897832843898	505 x 32 x 353	1		7897832843904	515 x 230 x 387	0	2	7	4202.12.10
2151.Q.0005	MALETA A3 DELLOFINE ROSA	7897832843478	505 x 32 x 353	1		7897832843485	515 x 230 x 387	0	2	7	4202.12.10
2151.R.0005	MALETA A3 DELLOFINE ROXA	7897832843492	505 x 32 x 353	1		7897832843508	515 x 230 x 387	0	2	7	4202.12.10
2151.S.0005	MALETA A3 DELLOFINE SORTIDA	7897832836289	505 x 32 x 353	1		7897832850124	515 x 230 x 387	0	2	7	4202.12.10
2152.A.0005	MALETA OFICIO DELLOFINE AMARELA	7897832845243	360 x 43 x 260	0		7897832845250	365 x 275 x 295	0	1	7	4202.12.10
2152.C.0005	MALETA OFICIO DELLOFINE AZUL	7897832842051	360 x 43 x 260	0		7897832842068	365 x 275 x 295	0	1	7	4202.12.10
2152.H.0005	MALETA OFICIO DELLOFINE CRISTAL	7897832842075	360 x 43 x 260	0		7897832842082	365 x 275 x 295	0	1	7	4202.12.10
2152.I.0005	MALETA OFICIO DELLOFINE FUME	7897832842099	360 x 43 x 260	0		7897832842105	365 x 275 x 295	0	1	7	4202.12.10
2152.P.0005	MALETA OFICIO DELLOFINE PRETA	7897832843553	360 x 43 x 260	0		7897832843560	365 x 275 x 295	0	1	7	4202.12.10
2152.Q.0005	MALETA OFICIO DELLOFINE ROSA	7897832842112	360 x 43 x 260	0		7897832842129	365 x 275 x 295	0	1	7	4202.12.10
2152.S.0005	MALETA OFICIO DELLOFINE SORTIDA	7897832844147	360 x 43 x 260	0		7897832842150	365 x 275 x 295	0	1	7	4202.12.10
2152.T.0005	MALETA OFICIO DELLOFINE VERDE	7897832843515	360 x 43 x 260	0		7897832843522	365 x 275 x 295	0	1	7	4202.12.10
2152.U.0005	MALETA OFICIO DELLOFINE VERMELHA	7897832845267	360 x 43 x 260	0		7897832845274	365 x 275 x 295	0	1	7	4202.12.10
2153.H.0005	MALETA A2 EXECUTIVE CRISTAL	7897832843133	710 x 30 x 500	1		7897832843140	720 x 230 x 530	0	5	7	4202.12.10
2153.P.0005	MALETA A2 EXECUTIVE PRETA	7897832843157	710 x 30 x 500	1		7897832843164	720 x 230 x 530	0	5	7	4202.12.10
2160.H.0005	MALETA SLIM LINE CRISTAL C/06 PTS. SUSP.KRAFT	7897832831611	390 x 90 x 260	0		7897832831628	508 x 416 x 290	0	4	7	4202.12.10

CÓDIGO	NOME	EAN13	MEDIDAS	ESPESSURA	GRAMATURA	EAN13 MASTER	MEDIDAS CAIXA	CUBAGEM	PESO TOTAL	IP1	NCM
2160.I.0005	MALETA SLIM LINE FUME C/06 PTS. SUSP. KRAFT	7897832831635	390 x 90 x 260	0		7897832831642	508 x 416 x 290	0	4	7	4202.12.10
2163.AU.0005	MALETA OFICIO SECRETS OURO	7897832869874	360 x 43 x 260	0		7897832869881	365 x 275 x 295	0	1	7	4202.12.10
2163.P.0005	MALETA OFICIO SECRETS PRETA	7897832869898	360 x 43 x 260	0		7897832869904	365 x 275 x 295	0	1	7	4202.12.10
2163.W.0005	MALETA OFICIO SECRETS ROSA	7897832869911	360 x 43 x 260	0		7897832869928	365 x 275 x 295	0	1	7	4202.12.10
2164.C.0005	MALETA OFICIO FULL COLOR AZUL	7897832889681	360 x 43 x 260	0		7897832889698	365 x 275 x 295	0	1	7	4202.12.10
2164.Q.0005	MALETA OFICIO FULL COLOR PINK	7897832889667	360 x 43 x 260	0		7897832889674	365 x 275 x 295	0	1	7	4202.12.10
2166.P.0006	MALETA SANFONADA OFICIO C/12 DIVISORIAS EXECUTIVE PRETA	7897832859011	380 x 35 x 260	0		7897832859028	385 x 302 x 215	0	3	7	4202.12.10
2169.C.0005	CAIXA ORGANIZADORA MINI / SAPATO AZUL	7897832849685	288 x 178 x 123	0		7897832849692	305 x 200 x 205	0	2	7	3924.90.00
2169.H.0005	CAIXA ORGANIZADORA MINI / SAPATO CRISTAL	7897832849708	288 x 178 x 123	0		7897832849715	305 x 200 x 205	0	2	7	3924.90.00
2169.P.0005	CAIXA ORGANIZADORA MINI / SAPATO PRETA	7897832849722	288 x 178 x 123	0		7897832849739	305 x 200 x 205	0	2	7	3924.90.00
2169.Q.0005	CAIXA ORGANIZADORA MINI / SAPATO ROSA	7897832849746	288 x 178 x 123	0		7897832849753	305 x 200 x 205	0	2	7	3924.90.00
2169.T.0005	CAIXA ORGANIZADORA MINI / SAPATO VERDE	7897832849784	288 x 178 x 123	0		7897832849791	305 x 200 x 205	0	2	7	3924.90.00
2169.U.0005	CAIXA ORGANIZADORA MINI / SAPATO VERMELHA	7897832849807	288 x 178 x 123	0		7897832849814	305 x 200 x 205	0	2	7	3924.90.00
2170.H.0005	CAIXA ORGANIZADORA PEQUENA CRISTAL	7897832849845	318 x 260 x 185	0		7897832849852	330 x 200 x 280	0	3	7	3924.90.00
2170.P.0005	CAIXA ORGANIZADORA PEQUENA PRETA	7897832849869	318 x 260 x 185	0		7897832849876	330 x 200 x 280	0	3	7	3924.90.00
2171.H.0005	CAIXA ORGANIZADORA MEDIA CRISTAL	7897832849944	390 x 300 x 190	0		7897832849951	404 x 195 x 322	0	3	7	3924.90.00
2171.P.0005	CAIXA ORGANIZADORA MEDIA PRETA	7897832849968	390 x 300 x 190	0		7897832849975	404 x 195 x 322	0	3	7	3924.90.00
2172.H.0005	CAIXA ORGANIZADORA GRANDE CRISTAL	7897832850049	425 x 320 x 200	1		7897832850056	442 x 203 x 345	0	4	7	3924.90.00
2172.P.0005	CAIXA ORGANIZADORA GRANDE PRETA	7897832850063	425 x 320 x 200	1		7897832850070	442 x 203 x 345	0	4	7	3924.90.00
2174.A.0005	CAIXA ORGANIZADORA AMARELA PADRAO CAMISA	7897832850841	392 x 278 x 64	0		7897832850858	410 x 340 x 300	0	2	7	3924.90.00
2174.C.0005	CAIXA ORGANIZADORA AZUL PADRAO CAMISA	7897832850865	392 x 278 x 64	0		7897832850872	410 x 340 x 300	0	2	7	3924.90.00
2174.H.0005	CAIXA ORGANIZADORA CRISTAL PADRAO CAMISA	7897832850889	392 x 278 x 64	0		7897832850896	410 x 340 x 300	0	2	7	3924.90.00
2174.P.0005	CAIXA ORGANIZADORA PRETA PADRAO CAMISA	7897832850902	392 x 278 x 64	0		7897832850919	410 x 340 x 300	0	2	7	3924.90.00
2174.Q.0005	CAIXA ORGANIZADORA ROSA PADRAO CAMISA	7897832850926	392 x 278 x 64	0		7897832850933	410 x 340 x 300	0	2	7	3924.90.00
2174.T.0005	CAIXA ORGANIZADORA VERDE PADRAO CAMISA	7897832850988	392 x 278 x 64	0		7897832850995	410 x 340 x 300	0	2	7	3924.90.00
2174.U.0005	CAIXA ORGANIZADORA VERMELHA PADRAO CAMISA	7897832851008	392 x 278 x 64	0		7897832851015	410 x 340 x 300	0	2	7	3924.90.00
2189.01.0005	CAIXA ORGANIZADORA BAIXA MEDIA FOLHAGEM	7897832879255	390 x 300 x 110	0		7897832879262	404 x 195 x 322	0	3	7	3924.90.00
2189.P.0005	CAIXA ORGANIZADORA BAIXA MEDIA PRETA	7897832855051	390 x 300 x 110	0		7897832855068	404 x 195 x 322	0	3	7	3924.90.00
2190.SS.0006	KIT DOCURA COM 5 PORTA OBJETOS	7897832869256	390 x 90 x 100	0		7897832869263	395 x 268 x 216	0	3	7	3924.90.00
2191.SS.0006	KIT MUNDO DA LUA COM 5 PORTA OBJETOS	7897832870641	390 x 90 x 100	0		7897832870658	395 x 268 x 216	0	3	7	3924.90.00
2192.P.0005	CAIXA ORGANIZADORA LINHO MEDIA PRETA	7897832854573	390 x 300 x 195	0		7897832854580	404 x 195 x 322	0	3	7	3924.90.00
2192.WP.0005	CAIXA ORGANIZADORA LINHO MEDIA SERENA ROSA PASTEL	7897832865371	390 x 300 x 195	0		7897832865388	404 x 195 x 322	0	3	7	3924.90.00
2193.H.0004	CAIXA ORGANIZADORA DE OBJETOS C/6 CRISTAL	7897832856416	240 x 175 x 100	0		7897832856423	370 x 248 x 219	0	2	7	3924.90.00
2193.W.0004	CAIXA ORGANIZADORA DE OBJETOS C/6 ROSA	7897832859561	240 x 175 x 100	0		7897832859578	370 x 248 x 219	0	2	7	3924.90.00
2194.H.0004	CAIXA ORGANIZADORA DE OBJETOS C/9 CRISTAL	7897832856515	260 x 240 x 100	0		7897832856522	492 x 271 x 219	0	4	7	3924.90.00
2197.08.0005	CAIXA ORGANIZADORA MEDIA FOLHAGEM	7897832879132	395 x 300 x 195	0		7897832879149	404 x 195 x 322	0	3	7	3924.90.00
2204.CP.0005	CAIXA ORGANIZADORA LINHO PEQUENA CAPPUCINO 25X25X15CM	7897832879194	250 x 250 x 150	0		7897832879200	275 x 206 x 281	0	2	7	3924.90.00
2204.G.0005	CAIXA ORGANIZADORA LINHO PEQUENA CINZA 25X25X15CM	7897832859660	250 x 250 x 150	0		7897832859677	275 x 206 x 281	0	2	7	3924.90.00
2204.P.0005	CAIXA ORGANIZADORA LINHO PEQUENA PRETA 25X25X15CM	7897832860581	250 x 250 x 150	0		7897832860598	275 x 206 x 281	0	2	7	3924.90.00
2204.VO.0005	CAIXA ORGANIZADORA LINHO PEQUENA VERDE OLIVE 25X25X15CM	7897832882002	250 x 250 x 150	0		7897832882019	275 x 206 x 281	0	2	7	3924.90.00
2204.W.0005	CAIXA ORGANIZADORA LINHO PEQUENA ROSA CLARO 25X25X15CM	7897832860703	250 x 250 x 150	0		7897832860710	275 x 206 x 281	0	2	7	3924.90.00
2205.G.0005	CAIXA ORGANIZADORA LINHO MEDIA CINZA 29X29X15CM	7897832859745	290 x 290 x 150	0		7897832859752	310 x 210 x 315	0	3	7	3924.90.00
2205.LV.0005	CAIXA ORGANIZADORA LINHO MEDIA LAVANDA 29X29X15CM	7897832882088	290 x 290 x 150	0		7897832882095	310 x 210 x 315	0	3	7	3924.90.00
2205.P.0005	CAIXA ORGANIZADORA LINHO MEDIA PRETA 29X29X15CM	7897832860628	290 x 290 x 150	0		7897832860635	310 x 210 x 315	0	3	7	3924.90.00
2205.VO.0005	CAIXA ORGANIZADORA LINHO MEDIA VERDE OLIVE 29X29X15CM	7897832882026	290 x 290 x 150	0		7897832882033	310 x 210 x 315	0	3	7	3924.90.00
2205.W.0005	CAIXA ORGANIZADORA LINHO MEDIA ROSA CLARO 29X29X15CM	7897832860727	290 x 290 x 150	0		7897832860734	310 x 210 x 315	0	3	7	3924.90.00
2206.CP.0005	CAIXA ORGANIZADORA LINHO GRANDE CAPPUCINO 35X35X16CM	7897832879231	350 x 350 x 160	0		7897832879248	370 x 208 x 378	0	3	7	3924.90.00
2206.G.0005	CAIXA ORGANIZADORA LINHO GRANDE CINZA 35X35X16CM	7897832859820	350 x 350 x 160	0		7897832859837	370 x 208 x 378	0	3	7	3924.90.00
2206.LV.0005	CAIXA ORGANIZADORA LINHO GRANDE LAVANDA 35X35X16CM	7897832882101	350 x 350 x 160	0		7897832882118	275 x 206 x 281	0	3	7	3924.90.00
2206.P.0005	CAIXA ORGANIZADORA LINHO GRANDE PRETA 35X35X16CM	7897832860666	350 x 350 x 160	0		7897832860673	370 x 208 x 378	0	3	7	3924.90.00
2206.VO.0005	CAIXA ORGANIZADORA LINHO GRANDE VERDE OLIVE 35X35X16CM	7897832882040	350 x 350 x 160	0		7897832882057	370 x 208 x 378	0	3	7	3924.90.00
2206.W.0005	CAIXA ORGANIZADORA LINHO GRANDE ROSA CLARO 35X35X16CM	7897832860741	350 x 350 x 160	0		7897832860758	370 x 208 x 378	0	3	7	3924.90.00
2290.SS.0006	MINI KIT DOCURA COM 4 PORTA OBJETOS	7897832875738	310 x 85 x 55	0		7897832875745	355 x 280 x 120	0	2	7	3924.90.00
2291.SS.0006	MINI KIT MUNDO DA LUA COM 4 PORTA OBJETOS	7897832875752	310 x 85 x 55	0		7897832875769	355 x 280 x 120	0	2	7	3924.90.00
2299.01.0006	KIT DUO FULL COLOR AZUL/VERDE LIMA0	7897832889278	156 x 81 x 98	0		7897832889285	355 x 260 x 118	0	1	7	3924.90.00
2299.02.0006	KIT DUO FULL COLOR ROSA/ROXO	7897832889292	156 x 81 x 98	0		7897832889308	355 x 260 x 118	0	1	7	3924.90.00
2302.E.0005	ORGANIZADOR DE DESPENSA GRANDE BRANCO	7897832871389	380 x 290 x 160	0		7897832871396	449 x 312 x 88	0	2	7	3924.90.00
2403.P.0006	CESTO DE LIXO PRETO 12,5 LTS	7897832851541	300 x 208 x 295	0		7897832851558	310 x 223 x 553	0	3	7	3924.90.00
2405.HB.0006	CESTO ORGANIZADOR P HERBAL	7897832866392	170 x 170 x 138	0		7897832866408	223 x 195 x 325	0	1	7	3924.90.00
2406.G.0006	CESTO ORGANIZADOR M CINZA	7897832866514	225 x 225 x 183	0		7897832866521	265 x 257 x 372	0	2	7	3924.90.00
2406.HB.0006	CESTO ORGANIZADOR M HERBAL	7897832866538	225 x 225 x 183	0		7897832866545	265 x 257 x 372	0	2	7	3924.90.00
2406.M.0006	CESTO ORGANIZADOR M MARROM	7897832868440	225 x 225 x 183	0		7897832868457	265 x 257 x 372	0	2	7	3924.90.00
2550.G.0005	CAIXA ORGANIZADORA MEDIA NATALINA	7897832865111	390 x 300 x 195	0		7897832865128	404 x 195 x 322	0	3	7	3924.90.00
3004.H.0012	ORGANIZADOR DE GAVETAS CRISTAL	7897832819060	261 x 240 x 23	2		7897832819077	297 x 255 x 285	0	3	10	3926.10.00
3004.P.0012	ORGANIZADOR DE GAVETAS PRETO	7897832805988	261 x 240 x 23	2		7897832806404	297 x 255 x 285	0	3	10	3926.10.00

CÓDIGO	NOME	EAN13	MEDIDAS	ESPESSURA	GRAMATURA	EAN13 MASTER	MEDIDAS CAIXA	CUBAGEM	PESO TOTAL	IP1	NCM
3005.H.0012	PORTA CANETAS CRISTAL	7897832808002	135 x 120 x 90			7897832808019	423 x 253 x 200	0	3	10	3926.10.00
3005.I.0012	PORTA CANETAS FUME	7897832808040	135 x 120 x 90			7897832808057	423 x 253 x 200	0	3	10	3926.10.00
3005.O.0012	PORTA CANETAS METALIZADO PRATA	7897832867030	135 x 120 x 90			7897832867047	423 x 253 x 200	0	3	10	3926.10.00
3005.RG.0012	PORTA CANETAS METALIZADO ROSE GOLD	7897832867054	135 x 120 x 90			7897832867061	423 x 253 x 200	0	3	10	3926.10.00
3005.S.0012	PORTA CANETAS SORTIDO	7897832835930	135 x 120 x 90			7897832818506	423 x 253 x 200	0	3	10	3926.10.00
3006.BP.0012	PRANCHETA OFICIO SERENA AZUL PASTEL C/12 UNI	7897832870603	360 x 240 x 40	3		7897832870610	365 x 247 x 255	0	3	10	3926.90.90
3006.E.0012	PRANCHETA BRANCA COM 12 UNIDADES	7897832839358	360 x 240 x 40	3		7897832839365	365 x 247 x 255	0	3	10	3926.90.90
3006.H.0012	PRANCHETA CRISTAL C/12 UN.	7897832808149	360 x 240 x 40	3		7897832808156	365 x 247 x 255	0	3	10	3926.90.90
3006.I.0012	PRANCHETA FUME C/12 UN.	7897832808125	360 x 240 x 40	3		7897832808132	365 x 247 x 255	0	3	10	3926.90.90
3006.LP.0012	PRANCHETA OFICIO SERENA LILAS PASTEL C/12 UNI	7897832869195	360 x 240 x 40	3		7897832869201	365 x 247 x 255	0	3	10	3926.90.90
3006.P.0012	PRANCHETA PRETA C/12 UN.	7897832818858	360 x 240 x 40	3		7897832818865	365 x 247 x 255	0	3	10	3926.90.90
3006.S.0012	PRANCHETA SORTIDA C/12 UN.	7897832836135	360 x 240 x 40	3		7897832820738	365 x 247 x 255	0	3	10	3926.90.90
3006.SS.0012	PRANCHETA OFICIO SERENA SORTIDA C/12 UNI	7897832870627	360 x 240 x 40	3		7897832870634	365 x 247 x 255	0	3	10	3926.90.90
3006.VP.0012	PRANCHETA OFICIO SERENA VERDE PASTEL C/12 UNI	7897832869218	360 x 240 x 40	3		7897832869225	365 x 247 x 255	0	3	10	3926.90.90
3006.WP.0012	PRANCHETA OFICIO SERENA ROSA PASTEL C/12 UNI	7897832869232	360 x 240 x 40	3		7897832869249	365 x 247 x 255	0	3	10	3926.90.90
3007.C.0012	PRANCHETA OFICIO FULL COLOR AZUL	7897832889551	360 x 240 x 40	3		7897832889568	365 x 247 x 255	0	3	10	3926.90.90
3007.K.0012	PRANCHETA OFICIO FULL COLOR LARANJA	7897832889575	360 x 240 x 40	3		7897832889582	365 x 247 x 255	0	3	10	3926.90.90
3007.Q.0012	PRANCHETA OFICIO FULL COLOR PINK	7897832889599	360 x 240 x 40	3		7897832889606	365 x 247 x 255	0	3	10	3926.90.90
3007.R.0012	PRANCHETA OFICIO FULL COLOR ROXO	7897832889612	360 x 240 x 40	3		7897832889629	365 x 247 x 255	0	3	10	3926.90.90
3007.S.0012	PRANCHETA OFICIO FULL COLOR SORTIDA	7897832890847	360 x 240 x 40	3		7897832890854	365 x 247 x 255	0	3	10	3926.90.90
3008.H.0012	PRANCHETA MEIO OFICIO CRISTAL C/12 UN.	7897832825764	255 x 160 x 40	3		7897832825771	275 x 260 x 190	0	2	10	3926.90.90
3008.I.0012	PRANCHETA MEIO OFICIO FUME C/12 UN.	7897832825788	255 x 160 x 40	3		7897832825795	275 x 260 x 190	0	2	10	3926.90.90
3009.C.0012	PRANCHETA 1/2 OFICIO FULL COLOR AZUL	7897832888813	255 x 160 x 40	3		7897832888820	275 x 260 x 190	0	2	10	3926.90.90
3009.K.0012	PRANCHETA 1/2 OFICIO FULL COLOR LARANJA	7897832888844	255 x 160 x 40	3		7897832888851	275 x 260 x 190	0	2	10	3926.90.90
3009.Q.0012	PRANCHETA 1/2 OFICIO FULL COLOR PINK	7897832888875	255 x 160 x 40	3		7897832888882	275 x 260 x 190	0	2	10	3926.90.90
3009.R.0012	PRANCHETA 1/2 OFICIO FULL COLOR ROXO	7897832888905	255 x 160 x 40	3		7897832888912	275 x 260 x 190	0	2	10	3926.90.90
3009.S.0012	PRANCHETA 1/2 OFICIO FULL COLOR SORTIDA	7897832890823	255 x 160 x 40	3		7897832890830	275 x 260 x 190	0	2	10	3926.90.90
3013.H.0012	PRANCHETA OFICIO COM PRESILHA DE PRESSAO CRISTAL	7897832885720	255 x 160 x 40	3		7897832885737	275 x 260 x 190	0	2	10	3926.90.90
3013.I.0012	PRANCHETA OFICIO COM PRESILHA DE PRESSAO FUME	7897832885744	255 x 160 x 40	3		7897832885751	275 x 260 x 190	0	2	10	3926.90.90
3014.H.0012	PRANCHETA OFICIO COM PRENDADOR METAL CRISTAL	7897832885768	255 x 160 x 40	3		7897832885775	275 x 260 x 190	0	2	10	3926.90.90
3014.I.0012	PRANCHETA OFICIO COM PRENDADOR METAL FUME	7897832885782	255 x 160 x 40	3		7897832885799	275 x 260 x 190	0	2	10	3926.90.90
3019.H.0012	PORTA OBJETOS PEQUENO CRISTAL (KIT C/4PCS)	7897832872164	82 x 77 x 52			7897832872171	315 x 176 x 235	0	0	7	3924.90.00
3019.LP.0012	PORTA OBJETOS PEQUENO LILAS PASTEL (KIT C/4PCS)	7897832872201	82 x 77 x 52			7897832872218	315 x 176 x 235	0	0	7	3924.90.00
3019.WP.0012	PORTA OBJETOS PEQUENO ROSA PASTEL (KIT C/4PCS)	7897832872249	82 x 77 x 52			7897832872256	315 x 176 x 235	0	0	7	3924.90.00
3020.BP.0006	PORTA OBJETOS AZUL PASTEL COM 3 DIVISORIAS	7897832875356	112 x 112 x 94			7897832875363	350 x 247 x 125	0	1	7	3924.90.00
3020.C.0006	PORTA OBJETOS FULL COLOR AZUL COM 3 DIVISORIAS	7897832889018	112 x 112 x 94			7897832889025	350 x 247 x 125	0	1	7	3924.90.00
3020.LP.0006	PORTA OBJETOS LILAS PASTEL COM 3 DIVISORIAS	7897832875370	112 x 112 x 94			7897832875387	350 x 247 x 125	0	1	7	3924.90.00
3020.P.0006	PORTA OBJETOS PRETO COM 3 DIVISORIAS	7897832875332	112 x 112 x 94			7897832875349	350 x 247 x 125	0	1	7	3924.90.00
3020.Q.0006	PORTA OBJETOS FULL COLOR PINK COM 3 DIVISORIAS	7897832889032	112 x 112 x 94			7897832889049	350 x 247 x 125	0	1	7	3924.90.00
3020.R.0006	PORTA OBJETOS FULL COLOR ROXO COM 3 DIVISORIAS	7897832889056	112 x 112 x 94			7897832889063	350 x 247 x 125	0	1	7	3924.90.00
3020.VL.0006	PORTA OBJETOS FULL COLOR VERDE LIMO COM 3 DIVISORIAS	7897832888998	112 x 112 x 94			7897832889001	350 x 247 x 125	0	1	7	3924.90.00
3020.WP.0006	PORTA OBJETOS ROSA PASTEL COM 3 DIVISORIAS	7897832875417	112 x 112 x 94			7897832875424	350 x 247 x 125	0	1	7	3924.90.00
3029.B.0012	PORTA OBJETOS DELLOCOLOR AZUL CLARO	7897832859509	80 x 77 x 97	2	0	7897832859516	260 x 170 x 220	0	1	7	3924.90.00
3029.BP.0012	PORTA OBJETOS AZUL PASTEL	7897832879552	80 x 77 x 97	2		7897832879569	260 x 170 x 220	0	1	7	3924.90.00
3029.H.0012	PORTA OBJETOS DELLOCOLOR CRISTAL	7897832851169	80 x 77 x 97	2	0	7897832851176	260 x 170 x 220	0	1	7	3924.90.00
3029.I.0012	PORTA OBJETOS DELLOCOLOR FUME	7897832851183	80 x 77 x 97	2	0	7897832851190	260 x 170 x 220	0	1	7	3924.90.00
3029.LP.0012	PORTA OBJETOS LILAS PASTEL	7897832879576	80 x 77 x 97	2		7897832879583	260 x 170 x 220	0	1	7	3924.90.00
3029.O.0012	PORTA OBJETOS METALIZADO PRATA	7897832867078	80 x 77 x 97	2	0	7897832867085	260 x 170 x 220	0	1	7	3924.90.00
3029.P.0012	PORTA OBJETOS DELLOCOLOR PRETO	7897832851206	80 x 77 x 97	2	0	7897832851213	260 x 170 x 220	0	1	7	3924.90.00
3029.S.0012	PORTA OBJETOS DELLOCOLOR SORTIDO	7897832851244	80 x 77 x 97	2	0	7897832851251	260 x 170 x 220	0	1	7	3924.90.00
3029.SM.0012	PORTA OBJETOS METALIZADO SORTIDO	7897832870177	80 x 77 x 97	2	0	7897832870184	260 x 170 x 220	0	1	7	3924.90.00
3029.W.0012	PORTA OBJETOS DELLOCOLOR ROSA	7897832859523	80 x 77 x 97	2	0	7897832859530	260 x 170 x 220	0	1	7	3924.90.00
3029.WP.0012	PORTA OBJETOS ROSA PASTEL	7897832879613	80 x 77 x 97	2		7897832879620	260 x 170 x 220	0	1	7	3924.90.00
3030.B.0012	PORTA CANETAS DUPLO AZUL CLARO	7897832866002	170 x 70 x 80	3	0	7897832866019	355 x 224 x 195	0	2	10	3926.10.00
3030.H.0012	PORTA CANETAS DUPLO CRISTAL	7897832851305	170 x 70 x 80	3	0	7897832851312	355 x 224 x 195	0	2	10	3926.10.00
3030.I.0012	PORTA CANETAS DUPLO FUME	7897832851329	170 x 70 x 80	3	0	7897832851336	355 x 224 x 195	0	2	10	3926.10.00
3030.O.0012	PORTA CANETAS DUPLO METALIZADO PRATA	7897832867115	170 x 70 x 80	3	0	7897832867122	355 x 224 x 195	0	2	10	3926.10.00
3030.P.0012	PORTA CANETAS DUPLO PRETO	7897832851343	170 x 70 x 80	3	0	7897832851350	355 x 224 x 195	0	2	10	3926.10.00
3030.RG.0012	PORTA CANETAS DUPLO METALIZADO ROSE GOLD	7897832867139	170 x 70 x 80	3	0	7897832867146	355 x 224 x 195	0	2	10	3926.10.00
3030.S.0012	PORTA CANETAS DUPLO SORTIDO	7897832851381	170 x 70 x 80	3	0	7897832851398	355 x 224 x 195	0	2	10	3926.10.00
3030.SM.0012	PORTA CANETAS DUPLO METALIZADO SORTIDO	7897832870191	170 x 70 x 80	3	0	7897832870207	355 x 224 x 195	0	2	10	3926.10.00
3030.W.0012	PORTA CANETAS DUPLO ROSA	7897832866958	170 x 70 x 80	3	0	7897832866965	355 x 224 x 195	0	2	10	3926.10.00
3031.B.0012	PORTA CANETAS TRIPLO AZUL CLARO	7897832866033	240 x 70 x 80	3	0	7897832866040	445 x 255 x 195	0	2	10	3926.10.00
3031.H.0012	PORTA CANETAS TRIPLO CRISTAL	7897832851442	240 x 70 x 80	3	0	7897832851459	445 x 255 x 195	0	2	10	3926.10.00
3031.I.0012	PORTA CANETAS TRIPLO FUME	7897832851466	240 x 70 x 80	3	0	7897832851473	445 x 255 x 195	0	2	10	3926.10.00

CÓDIGO	NOME	EAN13	MEDIDAS	ESPESSURA	GRAMATURA	EAN13 MASTER	MEDIDAS CAIXA	CUBAGEM	PESO TOTAL	IP1	NCM
3031.P.0012	PORTA CANETAS TRIPLO PRETO	7897832851480	240 x 70 x 80	3	0	7897832851497	445 x 255 x 195	0	2	10	3926.10.00
3031.S.0012	PORTA CANETAS TRIPLO SORTIDO	7897832851527	240 x 70 x 80	3		7897832851534	445 x 255 x 195	0	2	10	3926.10.00
3031.W.0012	PORTA CANETAS TRIPLO ROSA	7897832866996	240 x 70 x 80	3	0	7897832867009	445 x 255 x 195	0	2	10	3926.10.00
3034.H.0012	PORTA LAPIS, CLIPS E LEMBRETTE CRISTAL	7897832885645	230 x 66 x 90	3	0	7897832885652	400 x 232 x 140	0	2	10	3926.10.00
3034.I.0012	PORTA LAPIS, CLIPS E LEMBRETTE FUME	7897832885669	230 x 66 x 90	3	0	7897832885676	400 x 232 x 140	0	2	10	3926.10.00
3042.H.0008	CAIXA CORRESPONDENCIA SIMPLES CRISTAL	7897832854160	355 x 250 x 45			7897832854177	420 x 285 x 390	0	3	10	3926.10.00
3043.BP.0006.CH	CAIXA CORRESP. ARTICULAVEL DUPLA AZUL PASTEL CHILINCADO	7897832880985	355 x 250 x 90	2		7897832880992	530 x 278 x 385	0	5	10	3926.10.00
3043.H.0006	CAIXA CORRESPONDENCIA ARTICULAVEL DUPLA CRISTAL	7897832852067	355 x 250 x 90	2		7897832852074	530 x 278 x 385	0	5	10	3926.10.00
3043.H.0006.CH	CAIXA CORRESP. ARTICULAVEL DUPLA CRISTAL (CHILINCADO)	7897832855990	355 x 250 x 90	2		7897832856003	530 x 278 x 385	0	5	10	3926.10.00
3043.I.0006	CAIXA CORRESPONDENCIA ARTICULAVEL DUPLA FUME	7897832852081	355 x 250 x 90	2		7897832852098	530 x 278 x 385	0	5	10	3926.10.00
3043.I.0006.CH	CAIXA CORRESP. ARTICULAVEL DUPLA FUME (CHILINCADO)	7897832856010	355 x 250 x 90	2		7897832856027	530 x 278 x 385	0	5	10	3926.10.00
3043.LP.0006.CH	CAIXA CORRESP. ARTICULAVEL DUPLA LILAS PASTEL CHILINCADO	7897832881234	355 x 250 x 90	2		7897832881241	530 x 278 x 385	0	5	10	3926.10.00
3043.WP.0006.CH	CAIXA CORRESP. ARTICULAVEL DUPLA ROSA PASTEL CHILINCADO	7897832881029	355 x 250 x 90	2		7897832881036	530 x 278 x 385	0	5	10	3926.10.00
3043.P.0006.CH	CAIXA CORRESP. ARTICULAVEL DUPLA PRETA (CHILINCADO)	7897832865258	355 x 253 x 80	2		7897832865265	530 x 278 x 385	0	5	10	3926.10.00
3044.H.0004	CAIXA CORRESPONDENCIA ARTICULAVEL TRIPLA CRISTAL	7897832852128	355 x 253 x 125	2		7897832852135	530 x 278 x 385	0	5	10	3926.10.00
3044.H.0004.CH	CAIXA CORRESP. ARTICULAVEL TRIPLA CRISTAL (CHILINCADO)	7897832856072	355 x 253 x 125	2		7897832856089	530 x 278 x 385	0	5	10	3926.10.00
3044.I.0004	CAIXA CORRESPONDENCIA ARTICULAVEL TRIPLA FUME	7897832852142	355 x 253 x 125	2		7897832852159	530 x 278 x 385	0	5	10	3926.10.00
3044.I.0004.CH	CAIXA CORRESP. ARTICULAVEL TRIPLA FUME (CHILINCADO)	7897832856096	355 x 253 x 125	2		7897832856102	530 x 278 x 385	0	5	10	3926.10.00
3044.LP.0004.CH	CAIXA CORRESP. ARTICULAVEL TRIPLA LILAS PASTEL (CHILINCADO)	7897832881258	355 x 253 x 125	2		7897832881265	530 x 278 x 385	0	5	10	3926.10.00
3044.WP.0004.CH	CAIXA CORRESP. ARTICULAVEL TRIPLA ROSA PASTEL (CHILINCADO)	7897832881081	355 x 253 x 125	2		7897832881098	530 x 278 x 385	0	5	10	3926.10.00
3049.H.0005	CAIXA CORRESPONDENCIA FIXA DUPLA CRISTAL (CHILINCADO)	7897832894814	360 x 260 x 110	2		7897832894821	530 x 278 x 385	0	6	10	3926.10.00
3049.I.0005	CAIXA CORRESPONDENCIA FIXA DUPLA FUME (CHILINCADO)	7897832894838	360 x 260 x 110	2		7897832894845	530 x 278 x 385	0	6	10	3926.10.00
3050.H.0003	CAIXA CORRESPONDENCIA FIXA TRIPLA CRISTAL (CHILINCADO)	7897832894852	360 x 260 x 180	2		7897832894869	530 x 278 x 385	0	2	10	3926.10.00
3050.I.0003	CAIXA CORRESPONDENCIA FIXA TRIPLA FUME (CHILINCADO)	7897832894876	360 x 260 x 180	2		7897832894883	530 x 278 x 385	0	2	10	3926.10.00
3053.H.0003	EXPOSITOR MODULAR CRISTAL (KIT C/2PCS)	7897832872140	365 x 120 x 355			7897832872157	390 x 385 x 230	0	3	10	3926.10.00
3054.H.0006	EXPOSITOR CRISTAL	7897832852173	235 x 40 x 295	2		7897832852180	303 x 255 x 320	0	3	10	3926.10.00
3054.I.0006	EXPOSITOR FUME	7897832852197	235 x 40 x 295	2		7897832852203	303 x 255 x 320	0	3	10	3926.10.00
3055.H.0003	ORGANIZADOR DE DOCUMENTOS TRIPLO DELLOCOLOR CRISTAL	7897832835268	328 x 120 x 300	3		7897832835275	370 x 340 x 325	0	4	10	3926.10.00
3055.I.0003	ORGANIZADOR DE DOCUMENTOS TRIPLO DELLOCOLOR FM	7897832835282	328 x 120 x 300	3		7897832835299	370 x 340 x 325	0	4	10	3926.10.00
3071.H.0012	ORGANIZADOR DE COSMETICOS COMPACTO C/16 DIVISORIAS CRISTAL	7897832871808	112 x 112 x 75			7897832871815	350 x 247 x 125	0	3	7	3924.90.00
3072.H.0006	ORGANIZADOR DE COSMETICOS ESSENCIAL C/11 DIVISORIAS CRISTAL	7897832871846	238 x 113 x 75			7897832871853	353 x 251 x 145	0	3	7	3924.90.00
3073.H.0006	ORGANIZADOR DE COSMETICOS PLUS C/31 DIVISORIAS CRISTAL	7897832871860	238 x 238 x 75			7897832871877	497 x 251 x 197	0	4	7	3924.90.00
3074.H.0012	ORGANIZADOR DE COSMETICOS COMPACTO C/6 DIVISORIAS CRISTAL	7897832871822	112 x 112 x 75			7897832871839	350 x 247 x 125	0	2	7	3924.90.00
3075.H.0006	ORGANIZADOR COM TAMPA 3 DIVISORIAS CRISTAL	7897832871884	112 x 112 x 105			7897832871891	350 x 247 x 125	0	2	7	3924.90.00
3080.H.0012	CAIXA ORGANIZADORA MINI C/ TAMPA SOUL CRISTAL	7897832894593	126 x 126 x 55			7897832894609	265 x 135 x 163	0	1	7	3924.90.00
3080.HG.0012	CAIXA ORGANIZADORA MINI C/ TAMPA SOUL CRISTAL / NUDE	7897832871907	126 x 126 x 55			7897832871914	265 x 135 x 163	0	1	7	3924.90.00
3080.HG1.0012	CAIXA ORGANIZADORA MINI C/ TAMPA SOUL CRISTAL / GRAFITE	7897832871921	126 x 126 x 55			7897832871938	265 x 135 x 163	0	1	7	3924.90.00
3080.HW2.0012	CAIXA ORGANIZADORA MINI C/ TAMPA SOUL CRISTAL / ROSA	7897832872621	126 x 126 x 55			7897832872638	265 x 135 x 163	0	1	7	3924.90.00
3080.W2.0012	CAIXA ORGANIZADORA MINI C/ TAMPA SOUL ROSA / ROSA	7897832871945	126 x 126 x 55			7897832871952	265 x 135 x 163	0	1	7	3924.90.00
3081.H.0012	CAIXA ORGANIZADORA PEQUENA C/ TAMPA SOUL CRISTAL	7897832894616	254 x 125 x 55			7897832894623	330 x 330 x 135	0	3	7	3924.90.00
3081.HG.0012	CAIXA ORGANIZADORA PEQUENA C/ TAMPA SOUL CRISTAL / NUDE	7897832871969	254 x 125 x 55			7897832871976	330 x 330 x 135	0	2	7	3924.90.00
3081.HG1.0012	CAIXA ORGANIZADORA PEQUENA C/ TAMPA SOUL CRISTAL / GRAFITE	7897832871983	254 x 125 x 55			7897832871990	330 x 330 x 135	0	2	7	3924.90.00
3081.HW2.0012	CAIXA ORGANIZADORA PEQUENA C/ TAMPA SOUL CRISTAL / ROSA	7897832872683	254 x 125 x 55			7897832872690	330 x 330 x 135	0	2	7	3924.90.00
3081.W2.0012	CAIXA ORGANIZADORA PEQUENA C/ TAMPA SOUL ROSA / ROSA	7897832872003	254 x 125 x 55			7897832872010	330 x 330 x 135	0	2	7	3924.90.00
3082.H.0006	CAIXA ORGANIZADORA MEDIA C/ TAMPA SOUL CRISTAL	7897832894630	280 x 280 x 125			7897832894647	283 x 293 x 380	0	4	7	3924.90.00
3082.HG.0006	CAIXA ORGANIZADORA MEDIA C/ TAMPA SOUL CRISTAL / NUDE	7897832872027	280 x 280 x 125			7897832872034	283 x 293 x 380	0	3	7	3924.90.00
3082.HW2.0006	CAIXA ORGANIZADORA MEDIA C/ TAMPA SOUL CRISTAL / ROSA	7897832872744	280 x 280 x 125			7897832872751	283 x 293 x 380	0	3	7	3924.90.00
3083.HG.0005	CAIXA ORGANIZADORA GRANDE COM TAMPA SOUL CRISTAL / NUDE	7897832872089	424 x 300 x 185			7897832872096	432 x 408 x 306	0	5	7	3924.90.00
3083.HW2.0005	CAIXA ORGANIZADORA GRANDE COM TAMPA SOUL CRISTAL / ROSA	7897832872805	424 x 300 x 185			7897832872812	432 x 408 x 306	0	5	7	3924.90.00
3090.GG.0006	COMBO SOUL + COMPACTO 2 (NUDE / NUDE)	7897832873222	125 x 125 x 125			7897832873239	396 x 223 x 141	0	2	7	3924.90.00
3090.H.0006	COMBO SOUL + COMPACTO 2 CRISTAL	7897832894654	125 x 125 x 125			7897832894661	396 x 223 x 141	0	2	7	3924.90.00
3090.W2W2.0006	COMBO SOUL + COMPACTO 2 (ROSA / ROSA)	7897832873185	125 x 125 x 125			7897832873192	396 x 223 x 141	0	2	7	3924.90.00
3091.H.0006	COMBO SOUL + PORTA ALGODAO CRISTAL	7897832894678	125 x 125 x 155			7897832894685	392 x 269 x 169	0	2	7	3924.90.00
3091.HG.0006	COMBO SOUL + PORTA ALGODAO (CRISTAL / NUDE)	7897832873321	125 x 125 x 155			7897832873338	392 x 269 x 169	0	2	7	3924.90.00
3091.W2W2.0006	COMBO SOUL + PORTA ALGODAO (ROSA / ROSA)	7897832873260	125 x 125 x 155			7897832873277	392 x 269 x 169	0	2	7	3924.90.00
3092.H.0006	COMBO SOUL + ESSENCIAL CRISTAL	7897832894692	255 x 125 x 126			7897832894708	400 x 267 x 250	0	4	7	3924.90.00
3092.HG.0006	COMBO SOUL + ESSENCIAL (CRISTAL / NUDE)	7897832873406	255 x 125 x 126			7897832873413	400 x 267 x 250	0	3	7	3924.90.00
3092.HLP.0006	COMBO SOUL + ESSENCIAL (CRISTAL / LILAS)	7897832878319	255 x 125 x 126			7897832878326	400 x 267 x 250	0	3	7	3924.90.00
3093.GG.0004	COMBO SOUL + PLUS (NUDE / NUDE)	7897832873468	277 x 277 x 195			7897832873475	566 x 288 x 360	0	5	7	3924.90.00
3093.HG.0004	COMBO SOUL + PLUS (CRISTAL / NUDE)	7897832873482	277 x 277 x 195			7897832873499	566 x 288 x 360	0	5	7	3924.90.00
3093.HLP.0004	COMBO SOUL + PLUS (CRISTAL / LILAS)	7897832878333	277 x 277 x 195			7897832878340	566 x 288 x 360	0	5	7	3924.90.00
3100.H.0096	REGUA DE 30 CM DELLOCOLOR CRISTAL	7897832823227	310 x 34 x 3			7897832823258	325 x 177 x 108	0	3	10	3926.10.00
3101.H.0096	REGUA DE 30 CM POTENCIA CRISTAL (SOLAPA INDIVIDUAL)	7897832885867	310 x 35 x 0	3		7897832885874	325 x 177 x 108	0	3	10	3926.10.00
3102.H.0120	REGUA DE 30 CM POTENCIA CRISTAL (PCT C/ 10 UNID)	7897832885867	310 x 35 x 0	3		7897832885898	325 x 177 x 108	0	3	10	3926.10.00
3103.H.0120	REGUA DE 30 CM POTENCIA CRISTAL (CX DISPLAY)	7897832885867	310 x 35 x 0	3		7897832885911	329 x 197 x 70	0	3	10	3926.10.00

CÓDIGO	NOME	EAN13	MEDIDAS	ESPESSURA	GRAMATURA	EAN13 MASTER	MEDIDAS CAIXA	CUBAGEM	PESO TOTAL	IP1	NCM
3104.H.0350	REGUA DE 30 CM POTENCIA CRISTAL (A GRANEL)	7897832885867	310 x 35 x 0	3		7897832885935	330 x 330 x 135	0	10	10	3926.10.00
3107.H.0300	REGUA DE 30 CM ECONOMICA CRISTAL (PCT C/ 30 UNID)	7897832885942	310 x 26 x 0	2		7897832885959	320 x 150 x 165	0	3	10	3926.10.00
3107.H.0500	REGUA DE 30 CM ECONOMICA CRISTAL (A GRANEL)	7897832885942	310 x 26 x 0	2		7897832885973	320 x 150 x 165	0	6	10	3926.10.00
3109.H.0100	REGUA DE 30 CM DELLOCOLOR CRISTAL (CX DISPLAY)	7897832823227	310 x 34 x 3			7897832854153	329 x 197 x 70	0	3	10	3926.10.00
3110.H.0100	REGUA DE 30 CM DELLOCOLOR CRISTAL ECONOMICA	7897832823227	310 x 34 x 3			7897832824743	328 x 165 x 85	0	3	10	3926.10.00
3111.E.0096	REGUA DE 30 CM BLACK WHITE BRANCA	7897832839372	310 x 34 x 3			7897832839389	325 x 177 x 108	0	3	10	3926.10.00
3111.P.0096	REGUA DE 30 CM BLACK WHITE PRETA	7897832839402	310 x 34 x 3			7897832839419	325 x 177 x 108	0	3	10	3926.10.00
3111.S.0096	REGUA DE 30 CM BLACK WHITE SORTIDA	7897832849562	310 x 34 x 3			7897832843430	325 x 177 x 108	0	3	10	3926.10.00
3112.AP.0096	REGUA DE 30 CM SERENA AMARELO PASTEL	7897832863322	310 x 34 x 3			7897832863339	325 x 177 x 108	0	3	10	3926.10.00
3112.BP.0096	REGUA DE 30 CM SERENA AZUL PASTEL	7897832863353	310 x 34 x 3			7897832863360	325 x 177 x 108	0	3	10	3926.10.00
3112.LP.0096	REGUA DE 30 CM SERENA LILAS PASTEL	7897832863384	310 x 34 x 3			7897832863391	325 x 177 x 108	0	3	10	3926.10.00
3112.O.0096	REGUA DE 30 CM METALIZADA PRATA	7897832867191	310 x 34 x 3			7897832867207	325 x 177 x 108	0	3	10	3926.10.00
3112.SM.0120	REGUA DE 30 CM METALIZADA SORTIDA	7897832868570	310 x 34 x 3			7897832868587	360 x 237 x 90	0	4	10	3926.10.00
3112.SS.0120	REGUA DE 30 CM SERENA SORTIDA	7897832865692	310 x 34 x 3			7897832865708	325 x 177 x 108	0	4	10	3926.10.00
3112.VP.0096	REGUA DE 30 CM SERENA VERDE PASTEL	7897832863414	310 x 34 x 3			7897832863421	325 x 177 x 108	0	3	10	3926.10.00
3112.W.0096	REGUA DE 30 CM ROSA CLARO	7897832861861	310 x 34 x 3			7897832861878	325 x 177 x 108	0	3	10	3926.10.00
3112.WP.0096	REGUA DE 30 CM SERENA ROSA PASTEL	7897832863445	310 x 34 x 3			7897832863452	325 x 177 x 108	0	3	10	3926.10.00
3114.SS.0100	REGUA DE 30 CM SERENA SORTIDA (CX DISPLAY)	7897832867436	310 x 34 x 3			7897832867443	329 x 197 x 70	0	3	10	3926.10.00
3115.C.0096	REGUA DE 30 CM FULL COLOR AZUL	7897832888530	310 x 34 x 3			7897832888547	325 x 177 x 108	0	3	10	3926.10.00
3115.Q.0096	REGUA DE 30 CM FULL COLOR PINK	7897832888561	310 x 34 x 3			7897832888578	325 x 177 x 108	0	3	10	3926.10.00
3115.R.0096	REGUA DE 30 CM FULL COLOR ROXA	7897832888592	310 x 34 x 3			7897832888608	325 x 177 x 108	0	3	10	3926.10.00
3115.SFL.0100	REGUA DE 30 CM FULL COLOR SORTIDA (CX DISPLAY)	7897832888622	310 x 34 x 3			7897832888639	329 x 197 x 70	0	3	10	3926.10.00
3115.VL.0096	REGUA DE 30 CM FULL COLOR VERDE LIMAO	7897832888509	310 x 34 x 3			7897832888516	325 x 177 x 108	0	3	10	3926.10.00
3116.01.0096	REGUA DE 30 CM CHERRY	7897832894951	310 x 34 x 3			7897832894968	325 x 177 x 108	0	3	10	3926.10.00
3116.02.0096	REGUA DE 30 CM MORANGO	7897832894982	310 x 34 x 3			7897832894999	325 x 177 x 108	0	3	10	3926.10.00
3116.03.0096	REGUA DE 30 CM BRIGADEIRO	7897832895019	310 x 34 x 3			7897832895026	325 x 177 x 108	0	3	10	3926.10.00
3300.H.0020	GABARITO PARA ROUPAS CRISTAL (KIT COM 4 TAMANHOS)	7897832871266	250 x 0 x 345	0		7897832871273	350 x 260 x 80	0	3	7	3924.90.00
3301.E.0012	GABARITO P/ ROUPAS BRANCO - PP CORRUGADO (KIT C/ 5 TAM)	7897832893695	250 x 0 x 345	0		7897832893701	350 x 260 x 80	0	2	7	3924.90.00
4100.H.0100	FORRO PARA PRATELEIRAS E ARMARIOS 877X327MM	7897832873505	877 x 327 x 0	0		7897832873512	880 x 330 x 20	0	17	10	3919.10.10
4101.H.0100	FORRO PARA PRATELEIRAS E ARMARIOS 577X327MM	7897832873529	577 x 327 x 0	0		7897832873536	580 x 330 x 20	0	11	10	3919.10.10
4151.P.0020	DESK PAD PRETA 090X800X500MM	7897832879538	800 x 500 x 0	0		7897832879545	800 x 500 x 20	0	7	10	3919.10.10
4151.SI.0010	DESK PAD COM IMPRESSAO SORTIDO 090X800X500MM	7897832880459	800 x 500 x 0	0		7897832880466	800 x 500 x 10	0	3	10	3919.10.10
5022.BP.0006	PASTA FICHARIO INJETADO AZUL PASTEL C/ 4 ARGOLAS	7897832868150	270 x 45 x 315			7897832868167	370 x 208 x 378	0	3	10	3926.10.00
5022.H.0006	PASTA FICHARIO INJETADO CRISTAL C/ 4 ARGOLAS	7897832856270	270 x 45 x 315			7897832856287	370 x 208 x 378	0	3	10	3926.10.00
5022.LP.0006	PASTA FICHARIO INJETADO LILAS PASTEL C/ 4 ARGOLAS	7897832868174	270 x 45 x 315			7897832868181	370 x 208 x 378	0	3	10	3926.10.00
5022.P.0006	PASTA FICHARIO INJETADO PRETA C/ 4 ARGOLAS	7897832856294	270 x 45 x 315			7897832856300	370 x 208 x 378	0	3	10	3926.10.00
5022.WP.0006	PASTA FICHARIO INJETADO ROSA PASTEL C/ 4 ARGOLAS	7897832868198	270 x 45 x 315			7897832868204	370 x 208 x 378	0	3	10	3926.10.00
5036.MP.0006	PASTA FICHARIO PP SERENA PAPAYA	7897832877206	310 x 40 x 240	0		7897832877213	370 x 208 x 378	0	2	7	4202.12.10
5037.C.0006	PASTA FICHARIO PP FULL COLOR AZUL	7897832888936	310 x 40 x 240	0		7897832888943	370 x 208 x 378	0	2	7	4202.12.10
5037.Q.0006	PASTA FICHARIO PP FULL COLOR PINK	7897832888950	310 x 40 x 240	0		7897832888967	370 x 208 x 378	0	2	7	4202.12.10
5037.R.0006	PASTA FICHARIO PP FULL COLOR ROXO	7897832888974	310 x 40 x 240	0		7897832888981	370 x 208 x 378	0	2	7	4202.12.10
6023.B.0006	ORGANIZADOR DE OBJETOS DELLOCOLOR AZUL CLARO	7897832859462	245 x 87 x 280	3		7897832859479	431 x 275 x 300	0	3	7	3924.90.00
6023.H.0006	ORGANIZADOR DE OBJETOS DELLOCOLOR CRISTAL	7897832829601	245 x 87 x 280	3		7897832829618	431 x 275 x 300	0	3	7	3924.90.00
6023.I.0006	ORGANIZADOR DE OBJETOS DELLOCOLOR FUME	7897832829625	245 x 87 x 280	3		7897832829632	431 x 275 x 300	0	3	7	3924.90.00
6023.P.0006	ORGANIZADOR DE OBJETOS DELLOCOLOR PRETO	7897832838023	245 x 87 x 280	3		7897832838030	431 x 275 x 300	0	3	7	3924.90.00
6023.W.0006	ORGANIZADOR DE OBJETOS DELLOCOLOR ROSA	7897832859486	245 x 87 x 280	3		7897832859493	431 x 275 x 300	0	3	7	3924.90.00
6029.01.0005	ARQUIVO FULL COLOR C/ 5 ENVELOPES COLORIDOS	7897832889315	340 x 90 x 250			7897832889322	508 x 416 x 290	0	3	7	4202.12.10
6035.BP.0020	PASTA CATALOGO A4 SERENA AZUL PASTEL C/ 30 PLASTICOS	7897832875097	310 x 20 x 240	0		7897832875103	313 x 251 x 331	0	5	7	4202.12.10
6035.LP.0020	PASTA CATALOGO A4 SERENA LILAS PASTEL C/ 30 PLASTICOS	7897832875110	310 x 20 x 240	0		7897832875127	313 x 251 x 331	0	5	7	4202.12.10
6035.SS.0020	PASTA CATALOGO A4 SERENA SORTIDA C/ 30 PLASTICOS	7897832875271	310 x 20 x 240	0		7897832875288	313 x 251 x 331	0	5	7	4202.12.10
6035.WP.0020	PASTA CATALOGO A4 SERENA ROSA PASTEL C/ 30 PLASTICOS	7897832875158	310 x 20 x 240	0		7897832875165	313 x 251 x 331	0	5	7	4202.12.10
6036.A.0020	PASTA CATALOGO A4 AMARELA C/ 30 PLASTICOS	7897832883832	310 x 20 x 240	0		7897832883849	313 x 251 x 331	0	5	7	4202.12.10
6036.C.0020	PASTA CATALOGO A4 AZUL C/ 30 PLASTICOS	7897832883856	310 x 20 x 240	0		7897832883863	313 x 251 x 331	0	5	7	4202.12.10
6036.T.0020	PASTA CATALOGO A4 VERDE C/ 30 PLASTICOS	7897832883870	310 x 20 x 240	0		7897832883887	313 x 251 x 331	0	5	7	4202.12.10
6036.U.0020	PASTA CATALOGO A4 VERMELHA C/ 30 PLASTICOS	7897832883894	310 x 20 x 240	0		7897832883900	313 x 251 x 331	0	5	7	4202.12.10
6037.H.0020	PASTA CATALOGO A4 PP LINE CRISTAL C/10 PLASTICOS	7897832893916	310 x 20 x 240	0		7897832893923	313 x 251 x 331	0	2	7	4202.12.10
6037.I.0020	PASTA CATALOGO A4 PP LINE FUME C/10 PLASTICOS	7897832893954	310 x 20 x 240	0		7897832893961	313 x 251 x 331	0	2	7	4202.12.10
6037.P.0020	PASTA CATALOGO A4 PP LINE PRETA C/10 PLASTICOS	7897832893930	310 x 20 x 240	0		7897832893947	313 x 251 x 331	0	2	7	4202.12.10
6038.H.0020	PASTA CATALOGO A4 PP LINE CRISTAL C/30 PLASTICOS	7897832893978	310 x 20 x 240	0		7897832893985	313 x 251 x 331	0	4	7	4202.12.10
6038.I.0020	PASTA CATALOGO A4 PP LINE FUME C/30 PLASTICOS	7897832893992	310 x 20 x 240	0		7897832894005	313 x 251 x 331	0	4	7	4202.12.10
6038.P.0020	PASTA CATALOGO A4 PP LINE PRETA C/30 PLASTICOS	7897832894012	310 x 20 x 240	0		7897832894029	313 x 251 x 331	0	4	7	4202.12.10
6039.H.0010	PASTA CATALOGO A4 PP LINE CRISTAL C/50 PLASTICOS	7897832894036	310 x 20 x 240	0		7897832894043	313 x 251 x 331	0	3	7	4202.12.10
6039.I.0010	PASTA CATALOGO A4 PP LINE FUME C/50 PLASTICOS	7897832894050	310 x 20 x 240	0		7897832894067	313 x 251 x 331	0	3	7	4202.12.10
6039.P.0010	PASTA CATALOGO A4 PP LINE PRETA C/50 PLASTICOS	7897832894074	310 x 20 x 240	0		7897832894081	313 x 251 x 331	0	3	7	4202.12.10
6050.H.0020	PASTA CATALOGO A4 PP TOP LINE CRISTAL C/30 PLASTICOS	7897832826563	310 x 20 x 237			7897832826570	313 x 251 x 331	0	5	7	4202.12.10

CÓDIGO	NOME	EAN13	MEDIDAS	ESPESSURA	GRAMATURA	EAN13 MASTER	MEDIDAS CAIXA	CUBAGEM	PESO TOTAL	IP1	NCM
6050.I.0020	PASTA CATALOGO A4 PP TOP LINE FUME C/30 PLASTICOS	7897832826587	310 x 20 x 237			7897832826594	313 x 251 x 331	0	5	7	4202.12.10
6050.S.0020	PASTA CATALOGO A4 PP TOP LINE SORTIDA C/ 30 PLASTICOS	7897832835961	310 x 20 x 237			7897832829519	313 x 251 x 331	0	5	7	4202.12.10
6053.H.0020	PASTA CATALOGO A4 PP TOP LINE CRISTAL C/20 PLASTICOS	7897832846721	310 x 20 x 237			7897832846738	313 x 251 x 331	0	4	7	4202.12.10
6053.I.0020	PASTA CATALOGO A4 PP TOP LINE FUME C/20 PLASTICOS	7897832846745	310 x 20 x 237			7897832846752	313 x 251 x 331	0	4	7	4202.12.10
6053.S.0020	PASTA CATALOGO A4 PP TOP LINE SORTIDA C/20 PLASTICOS	7897832852241	310 x 20 x 237			7897832852258	313 x 251 x 331	0	4	7	4202.12.10
6054.H.0020	PASTA CATALOGO A4 PP TOP LINE CRISTAL C/40 PLASTICOS	7897832846783	310 x 20 x 237	0		7897832846790	313 x 251 x 331	0	6	7	4202.12.10
6054.I.0020	PASTA CATALOGO A4 PP TOP LINE FUME C/40 PLASTICOS	7897832846806	310 x 20 x 237	0		7897832846813	313 x 251 x 331	0	6	7	4202.12.10
6054.S.0020	PASTA CATALOGO A4 PP TOP LINE SORTIDA C/40 PLASTICOS	7897832852265	310 x 20 x 237	0		7897832852272	313 x 251 x 331	0	6	7	4202.12.10
6056.P.0020	PASTA CATALOGO A4 EXECUTIVE PRETA C/30 PLASTICOS	7897832858632	310 x 20 x 240			7897832858649	313 x 251 x 331	0	5	7	4202.12.10
6057.P.0020	PASTA CATALOGO A4 EXECUTIVE PRETA C/10 PLASTICOS	7897832860925	310 x 20 x 240	0		7897832860932	313 x 251 x 331	0	3	7	4202.12.10
6058.P.0010	PASTA CATALOGO A4 EXECUTIVE PRETA C/50 PLASTICOS	7897832860949	310 x 20 x 240	0		7897832860956	313 x 251 x 331	0	3	7	4202.12.10
6059.P.0010	PASTA CATALOGO A4 EXECUTIVE PRETA C/100 PLASTICOS	7897832860963	310 x 32 x 233	0		7897832860970	313 x 251 x 331	0	5	7	4202.12.10
6069.H.0012	PASTA SANF. PT. CH. LINE CRISTAL C/12 DIV.	7897832845960	262 x 25 x 140	0		7897832845977	285 x 203 x 280	0	2	7	4202.12.10
6069.I.0012	PASTA SANF. PT. CH. LINE FUME C/12 DIV.	7897832845984	262 x 25 x 140	0		7897832845991	285 x 203 x 280	0	2	7	4202.12.10
6069.S.0012	PASTA SANF. PT. CH. LINE SORTIDA C/12 DIV.	7897832848930	262 x 25 x 140	0		7897832848947	285 x 203 x 280	0	2	7	4202.12.10
6070.C.0012	PASTA SANF. A4 AZUL C/12 DIV.	7897832826822	330 x 32 x 236	0		7897832826839	360 x 340 x 262	0	4	7	4202.12.10
6070.H.0012	PASTA SANF. A4 CRISTAL C/12 DIV.	7897832826846	330 x 32 x 236	0		7897832826853	360 x 340 x 262	0	4	7	4202.12.10
6070.I.0012	PASTA SANF. A4 FUME C/12 DIV.	7897832826860	330 x 32 x 236	0		7897832826877	360 x 340 x 262	0	4	7	4202.12.10
6070.P.0012	PASTA SANF. A4 PRETA C/12 DIV.	7897832839808	330 x 32 x 236	0		7897832839815	360 x 340 x 262	0	4	7	4202.12.10
6070.Q.0012	PASTA SANF. A4 ROSA PINK C/12 DIV.	7897832839853	330 x 32 x 236	0		7897832839860	360 x 340 x 262	0	4	7	4202.12.10
6070.R.0012	PASTA SANF. A4 ROXA C/12 DIV.	7897832839839	330 x 32 x 236	0		7897832839846	360 x 340 x 262	0	4	7	4202.12.10
6070.S.0012	PASTA SANF. A4 SORTIDA C/12 DIV.	7897832835978	330 x 32 x 236	0		7897832829540	360 x 340 x 262	0	4	7	4202.12.10
6072.H.0006	PASTA SANF. A4 FINE CRISTAL C/31 DIV.	7897832829090	330 x 65 x 240	0		7897832829106	381 x 346 x 276	0	4	7	4202.12.10
6072.I.0006	PASTA SANF. A4 FINE FUME C/31 DIV.	7897832829113	330 x 65 x 240	0		7897832829120	381 x 346 x 276	0	4	7	4202.12.10
6076.H.0012	PASTA SANF. PT. CH. LINE CRISTAL C/31 DIV.	7897832846028	262 x 65 x 145	0		7897832846035	446 x 282 x 287	0	4	7	4202.12.10
6076.I.0012	PASTA SANF. PT. CH. LINE FUME C/31 DIV.	7897832846042	262 x 65 x 145	0		7897832846059	446 x 282 x 287	0	4	7	4202.12.10
6076.S.0012	PASTA SANF. PT. CH. LINE SORTIDA C/31 DIV.	7897832848954	262 x 65 x 145	0		7897832848961	446 x 282 x 287	0	4	7	4202.12.10
6077.C.0006	PASTA SANF. A4 LINE AZUL C/31 DIV.	7897832846066	331 x 55 x 265	0		7897832846073	381 x 346 x 276	0	4	7	4202.12.10
6077.H.0006	PASTA SANF. A4 LINE CRISTAL C/31 DIV.	7897832846080	331 x 55 x 265	0		7897832846097	381 x 346 x 276	0	4	7	4202.12.10
6077.I.0006	PASTA SANF. A4 LINE FUME C/31 DIV.	7897832846103	331 x 55 x 265	0		7897832846110	381 x 346 x 276	0	4	7	4202.12.10
6077.S.0006	PASTA SANF. A4 LINE SORTIDA C/31 DIV.	7897832848978	331 x 55 x 265	0		7897832848985	381 x 346 x 276	0	4	7	4202.12.10
6079.C.0012	PASTA SANF. A4 LINE AZUL C/12 DIV.	7897832846127	330 x 31 x 244	0		7897832846134	360 x 340 x 262	0	3	7	4202.12.10
6079.H.0012	PASTA SANF. A4 LINE CRISTAL C/12 DIV.	7897832846141	330 x 31 x 244	0		7897832846158	360 x 340 x 262	0	3	7	4202.12.10
6079.I.0012	PASTA SANF. A4 LINE FUME C/12 DIV.	7897832846165	330 x 31 x 244	0		7897832846172	360 x 340 x 262	0	3	7	4202.12.10
6079.Q.0012	PASTA SANF. A4 LINE ROSA C/12 DIV.	7897832849067	330 x 31 x 244	0		7897832849074	360 x 340 x 262	0	3	7	4202.12.10
6079.S.0012	PASTA SANF. A4 LINE SORTIDA C/12 DIV.	7897832848992	330 x 31 x 244	0		7897832849005	360 x 340 x 262	0	3	7	4202.12.10
6081.P.0012	PASTA SANFONADA DUPLICATA EXECUTIVE PRETA C/12 DIVISORIAS	7897832865395	250 x 31 x 182	0		7897832865401	285 x 203 x 280	0	2	7	4202.12.10
6082.P.0006	PASTA SANFONADA DUPLICATA EXECUTIVE PRETA C/31 DIVISORIAS	7897832865432	240 x 70 x 197	0		7897832865449	285 x 203 x 280	0	2	7	4202.12.10
6091.P.0012	PASTA SANFONADA A4 SECRETS PRETA C/ 12 DIVISORIAS	7897832869959	331 x 32 x 242			7897832869966	360 x 340 x 262	0	4	7	4202.12.10
6093.H.0006	PASTA SANFONADA OFICIO TOP LINE CRISTAL C/12 DIVISORIAS	7897832858212	382 x 35 x 263			7897832858229	385 x 302 x 215	0	3	7	4202.12.10
6094.H.0012	PASTA SANFONADA A4 EXECUTIVE CRISTAL C/12 DIVISORIAS	7897832867016	331 x 32 x 244			7897832867023	360 x 340 x 262	0	4	7	4202.12.10
6094.P.0012	PASTA SANFONADA A4 EXECUTIVE PRETA C/ 12 DIVISORIAS	7897832858588	331 x 32 x 244			7897832858595	360 x 340 x 262	0	4	7	4202.12.10
6094.S.0012	PASTA SANFONADA A4 EXECUTIVE SORTIDA C/12 DIVISORIAS	7897832870252	331 x 32 x 244			7897832870269	360 x 340 x 262	0	4	7	4202.12.10
6094.W.0012	PASTA SANFONADA A4 EXECUTIVE ROSA C/ 12 DIVISORIAS	7897832860192	331 x 32 x 244			7897832860208	360 x 340 x 262	0	4	7	4202.12.10
6096.BP.0012	PASTA SANFONADA A4 LINHO SERENA AZUL PASTEL C/12DIV.	7897832864237	330 x 30 x 236	0		7897832864244	360 x 340 x 262	0	4	7	4202.12.10
6096.LP.0012	PASTA SANFONADA A4 LINHO SERENA LILAS PASTEL C/12DIV.	7897832864251	330 x 30 x 236	0		7897832864268	360 x 340 x 262	0	4	7	4202.12.10
6096.S.0012	PASTA SANFONADA A4 LINHO SERENA SORTIDA C/12DIV.	7897832864312	330 x 30 x 240	0		7897832864329	360 x 340 x 262	0	4	7	4202.12.10
6096.VP.0012	PASTA SANFONADA A4 LINHO SERENA VERDE PASTEL C/12DIV.	7897832864275	330 x 30 x 236	0		7897832864282	360 x 340 x 262	0	4	7	4202.12.10
6096.WP.0012	PASTA SANFONADA A4 LINHO SERENA ROSA PASTEL C/12DIV.	7897832864299	330 x 30 x 236	0		7897832864305	360 x 340 x 262	0	4	7	4202.12.10
6097.BP.0006	PASTA SANFONADA A4 LINHO SERENA AZUL PASTEL C/31DIV.	7897832864350	330 x 70 x 250	0		7897832864367	381 x 346 x 276	0	4	7	4202.12.10
6097.LP.0006	PASTA SANFONADA A4 LINHO SERENA LILAS PASTEL C/31DIV.	7897832864374	330 x 70 x 250	0		7897832864381	381 x 346 x 276	0	4	7	4202.12.10
6097.WP.0006	PASTA SANFONADA A4 LINHO SERENA ROSA PASTEL C/31DIV.	7897832864411	330 x 70 x 250	0		7897832864428	381 x 346 x 276	0	4	7	4202.12.10
6106.C.0012	PASTA SANFONADA MINI FULL COLOR AZUL C/ 12 DIVISORIAS	7897832890984	250 x 31 x 182	0		7897832890991	330 x 200 x 280	0	2	7	4202.12.10
6106.K.0012	PASTA SANFONADA MINI FULL COLOR LARANJA C/ 12 DIVISORIAS	7897832888653	250 x 31 x 182	0		7897832888660	330 x 200 x 280	0	2	7	4202.12.10
6106.Q.0012	PASTA SANFONADA MINI FULL COLOR PINK C/ 12 DIVISORIAS	7897832888677	250 x 31 x 182	0		7897832888684	330 x 200 x 280	0	2	7	4202.12.10
6106.R.0012	PASTA SANFONADA MINI FULL COLOR ROXO C/ 12 DIVISORIAS	7897832888691	250 x 31 x 182	0		7897832888707	330 x 200 x 280	0	2	7	4202.12.10
6107.C.0012	PASTA SANFONADA A4 FULL COLOR AZUL C/ 12 DIVISORIAS	7897832888738	331 x 32 x 244	0		7897832888745	360 x 340 x 262	0	4	7	4202.12.10
6107.K.0012	PASTA SANFONADA A4 FULL COLOR LARANJA C/ 12 DIVISORIAS	7897832888752	331 x 32 x 244	0		7897832888769	360 x 340 x 262	0	4	7	4202.12.10
6107.Q.0012	PASTA SANFONADA A4 FULL COLOR PINK C/ 12 DIVISORIAS	7897832888776	331 x 32 x 244	0		7897832888783	360 x 340 x 262	0	4	7	4202.12.10
6107.R.0012	PASTA SANFONADA A4 FULL COLOR ROXO C/ 12 DIVISORIAS	7897832888790	331 x 32 x 244	0		7897832888806	360 x 340 x 262	0	4	7	4202.12.10
6107.S.0012	PASTA SANFONADA A4 FULL COLOR SORTIDA 12 DIVISORIAS	7897832889537	331 x 32 x 244	0		7897832889643	360 x 340 x 262	0	4	7	4202.12.10
6107.VL.0012	PASTA SANFONADA A4 FULL COLOR VERDE LIMAO C/ 12 DIVISORIAS	7897832888714	331 x 32 x 244	0		7897832888721	360 x 340 x 262	0	4	7	4202.12.10
6413.E.0008	KIT C/ 3 PORTA OBJETOS BRANCO	7897832893855	80 x 76 x 210			7897832893862	315 x 176 x 235	0	2	7	3924.90.00
6413.H.0008	KIT C/ 3 PORTA OBJETOS CRISTAL	7897832856638	80 x 76 x 210			7897832856645	315 x 176 x 235	0	2	7	3924.90.00
6413.P.0008	KIT C/ 3 PORTA OBJETOS PRETO	7897832856652	80 x 76 x 210			7897832856669	315 x 176 x 235	0	2	7	3924.90.00

CÓDIGO	NOME	EAN13	MEDIDAS	ESPESSURA	GRAMATURA	EAN13 MASTER	MEDIDAS CAIXA	CUBAGEM	PESO TOTAL	IP1	NCM
6413.W.0008	KIT C/ 3 PORTA OBJETOS ROSA	7897832859448	80 x 76 x 210			7897832859455	315 x 176 x 235	0	2	7	3924.90.00
6417.E.0012	KIT C/ 2 PORTA OBJETOS BRANCO (GDE / PEQ)	7897832893817	82 x 77 x 125			7897832893824	315 x 176 x 235	0	1	7	3924.90.00
6417.H.0012	KIT C/ 2 PORTA OBJETOS CRISTAL (GDE / PEQ)	7897832893794	82 x 77 x 125			7897832893800	315 x 176 x 235	0	1	7	3924.90.00
6417.P.0012	KIT C/ 2 PORTA OBJETOS PRETO (GDE / PEQ)	7897832893831	82 x 77 x 125			7897832893848	315 x 176 x 235	0	1	7	3924.90.00
6513.C.0008	KIT C/ 3 PORTA OBJETOS FULL COLOR AZUL	7897832890601	80 x 76 x 210			7897832890618	315 x 176 x 235	0	2	7	3924.90.00
6513.Q.0008	KIT C/ 3 PORTA OBJETOS FULL COLOR PINK	7897832890625	80 x 76 x 210			7897832890632	315 x 176 x 235	0	2	7	3924.90.00
6513.R.0008	KIT C/ 3 PORTA OBJETOS FULL COLOR ROXO	7897832890649	80 x 76 x 210			7897832890656	315 x 176 x 235	0	2	7	3924.90.00
6513.VL.0008	KIT C/ 3 PORTA OBJETOS FULL COLOR VERDE LIMAO	7897832890663	80 x 76 x 210			7897832890670	315 x 176 x 235	0	2	7	3924.90.00
6551.H.0006	TAPETE PROTETOR DE PISO CRISTAL 1200X1000MM	7897832856379	1200 x 1000 x 0	0		7897832856386	395 x 268 x 1027	0	7	10	3920.20.90
6551.P.0006	TAPETE PROTETOR DE PISO PRETO 1200X1000MM	7897832856393	1200 x 1000 x 0	0		7897832856409	395 x 268 x 1027	0	7	10	3920.20.90
6553.BP.0030	MOUSE PAD AZUL PASTEL	7897832880572	210 x 210 x 0	0		7897832880589	355 x 250 x 55	0	1	10	3919.10.10
6553.P.0030	MOUSE PAD PRETO	7897832880657	210 x 210 x 0	0		7897832880664	355 x 250 x 55	0	1	10	3919.10.10
6553.VP.0030	MOUSE PAD VERDE PASTEL	7897832880619	210 x 210 x 0	0		7897832880626	355 x 250 x 55	0	1	10	3919.10.10
8100.H.0200	ESQUADRO 21X45 POLIPROPILENO FLEXIVEL (SOLAPA INDIVIDUAL)	7897832857215	141 x 0 x 141	0		7897832857222	328 x 165 x 85	0	2	10	9017.20.00
8110.H.0300	ESQUADRO 21X45 POLIPROPILENO FLEXIVEL (CARTUCHO C/ 30 UN)	7897832857215	141 x 141 x 0	0		7897832857239	320 x 150 x 165	0	2	10	9017.20.00
8120.H.0200	ESQUADRO 45º POTENCIA CRISTAL (SOLAPA INDIVIDUAL)	7897832885980	145 x 145 x 0	3		7897832885997	396 x 223 x 141	0	5	10	9017.20.00
8121.H.0200	ESQUADRO 45º POTENCIA CRISTAL (PCT C/ 10 UNID)	7897832885980	145 x 145 x 0	3		7897832886017	320 x 150 x 165	0	5	10	9017.20.00
8130.H.0200	ESQUADRO 45º ECONOMICA (PCT C/ 20 UNID)	7897832886024	145 x 145 x 0	2		7897832886031	325 x 177 x 108	0	3	10	9017.20.00
8131.H.0400	ESQUADRO 45º ECONOMICA (A GRANEL)	7897832886024	145 x 145 x 0	2		7897832886437	320 x 150 x 165	0	6	10	9017.20.00
8132.H.0100	ESQUADRO 45º ECONOMICA (CX DISPLAY)	7897832886024	145 x 145 x 0	2		78978328891141	162 x 164 x 95	0	2	10	9017.20.00
8200.H.0200	ESQUADRO 21X60 POLIPROPILENO FLEXIVEL (SOLAPA INDIVIDUAL)	7897832857253	210 x 0 x 122	0		7897832857260	355 x 250 x 55	0	2	10	9017.20.00
8210.H.0300	ESQUADRO 21X60 POLIPROPILENO FLEXIVEL (CARTUCHO C/ 30 UN)	7897832857253	210 x 122 x 0	0		7897832857277	320 x 150 x 165	0	3	10	9017.20.00
8220.H.0200	ESQUADRO 60º POTENCIA CRISTAL (SOLAPA INDIVIDUAL)	7897832886048	170 x 22 x 0	3		7897832886055	396 x 223 x 141	0	5	10	9017.20.00
8221.H.0200	ESQUADRO 60º POTENCIA CRISTAL (PCT C/ 10 UNID)	7897832886048	170 x 22 x 0	3		7897832886079	396 x 223 x 141	0	5	10	9017.20.00
8230.H.0200	ESQUADRO 60º ECONOMICA (PCT C/ 20 UNID)	7897832886086	170 x 22 x 0	2		7897832886093	320 x 150 x 165	0	4	10	9017.20.00
8231.H.0400	ESQUADRO 60º ECONOMICA (A GRANEL)	7897832886086	170 x 22 x 0	2		7897832886475	644 x 521 x 55	0	0	10	9017.20.00
8232.H.0100	ESQUADRO 60º ECONOMICA (CX DISPLAY)	7897832886086	170 x 22 x 0	2		78978328891158	222 x 135 x 90	0	2	10	9017.20.00
8300.H.0200	TRANSFERIDOR 180º POLIPROPILENO FLEXIVEL (SOLAPA INDIVIDUAL)	7897832857291	150 x 0 x 84	0		7897832857307	325 x 177 x 108	0	2	10	9017.20.00
8310.H.0300	TRANSFERIDOR 180º POLIPROPILENO FLEXIVEL (CART C/ 30 UNID)	7897832857291	150 x 84 x 0	0		7897832857314	320 x 150 x 165	0	2	10	9017.20.00
8320.H.0200	TRANSFERIDOR 180º POTENCIA CRISTAL (SOLAPA INDIVIDUAL)	7897832886109	144 x 81 x 0	3		7897832886116	396 x 223 x 141	0	3	10	9017.20.00
8321.H.0200	TRANSFERIDOR 180º POTENCIA CRISTAL (PCT C/ 10 UNID)	7897832886109	144 x 81 x 0	3		7897832886130	320 x 150 x 165	0	3	10	9017.20.00
8330.H.0200	TRANSFERIDOR 180º ECONOMICA (PCT C/ 20 UNID)	7897832886147	144 x 81 x 0	2		7897832886154	325 x 177 x 108	0	2	10	9017.20.00
8331.H.0400	TRANSFERIDOR 180º ECONOMICA (A GRANEL)	7897832886147	144 x 81 x 0	2		7897832886499	320 x 150 x 165	0	4	10	9017.20.00
8332.H.0100	TRANSFERIDOR 180º ECONOMICA (CX DISPLAY)	7897832886147	144 x 81 x 0	2		78978328891165	181 x 155 x 102	0	1	10	9017.20.00
8400.H.0200	TRANSFERIDOR 360º POLIPROPILENO FLEXIVEL (SOLAPA INDIVIDUAL)	7897832857338	122 x 0 x 122	0		7897832857345	325 x 220 x 92	0	2	10	9017.20.00
8410.H.0300	TRANSFERIDOR 360º POLIPROPILENO FLEXIVEL (CART C/ 30)	7897832857338	122 x 122 x 0	0		7897832857352	320 x 150 x 165	0	3	10	9017.20.00
8420.H.0200	TRANSFERIDOR 360º POTENCIA CRISTAL (SOLAPA INDIVIDUAL)	7897832886161	120 x 120 x 0	3		7897832886178	396 x 223 x 141	0	4	10	9017.20.00
8421.H.0200	TRANSFERIDOR 360º POTENCIA CRISTAL (PCT C/ 10)	7897832886161	120 x 120 x 0	3		7897832886192	275 x 260 x 190	0	4	10	9017.20.00
8430.H.0200	TRANSFERIDOR 360º ECONOMICA (PCT C/ 20 UNID)	7897832886192	120 x 120 x 0	2		7897832886208	320 x 150 x 165	0	3	10	9017.20.00
8431.H.0400	TRANSFERIDOR 360º ECONOMICA (A GRANEL)	7897832886192	120 x 120 x 0	2		7897832886512	275 x 260 x 190	0	5	10	9017.20.00
8432.H.0100	TRANSFERIDOR 360º ECONOMICA (CX DISPLAY)	7897832886192	120 x 120 x 0	2		78978328891172	253 x 128 x 80	0	1	10	9017.20.00
8500.H.0200	REGUA 30 CM POLIPROPILENO FLEXIVEL (SOLAPA C/ 20 UNID)	7897832857376	310 x 0 x 32	0		7897832857383	328 x 165 x 85	0	2	10	3926.10.00
8510.H.0300	REGUA 30 CM POLIPROPILENO FLEXIVEL (CARTUCHO C/ 50 UNID)	7897832857376	310 x 33 x 0	0		7897832857390	320 x 150 x 165	0	3	10	3926.10.00
8610.H.0200	REGUA 15CM POLIPROPILENO FLEXIVEL (CARTUCHO C/ 20 UNID)	7897832868600	310 x 0 x 16	0		7897832868617	181 x 140 x 110	0	1	10	3926.10.00
8700.H.0050	KIT P/ DESENHO ESCOLAR 1/2º GRAU POLIPROPILENO FLEXIVEL	7897832857444	310 x 135 x 0	0		7897832857451	320 x 150 x 165	0	2	10	9017.20.00
8720.H.0100	KIT GEOMETRICO 1º GRAU POTENCIA	7897832886222	315 x 160 x 0	3		7897832886239	400 x 275 x 300	0	10	10	9017.20.00
8721.H.0100	KIT GEOMETRICO 2º GRAU POTENCIA	7897832886529	315 x 160 x 0	3		7897832886536	400 x 275 x 300	0	10	10	9017.20.00
8730.H.0200	KIT GEOMETRICO 1º GRAU ECONOMICA	7897832886246	315 x 160 x 0	2		7897832886253	400 x 275 x 300	0	11	10	9017.20.00
8731.H.0200	KIT GEOMETRICO 2º GRAU ECONOMICA	7897832886543	315 x 160 x 0	2		7897832886550	400 x 275 x 300	0	11	10	9017.20.00
8800.BP.0030	ESTOJO MULTIUSO LINHO SERENA AZUL PASTEL	7897832863827	200 x 30 x 70	0		7897832863834	370 x 265 x 215	0	1	10	3926.10.00
8800.LP.0030	ESTOJO MULTIUSO LINHO SERENA LILAS PASTEL	7897832863841	200 x 30 x 70	0		7897832863858	370 x 265 x 215	0	1	10	3926.10.00
8800.P.0030	ESTOJO MULTIUSO LINHO PRETO	7897832868365	200 x 30 x 70	0		7897832868372	370 x 265 x 215	0	1	10	3926.10.00
8800.S.0030	ESTOJO MULTIUSO LINHO SERENA SORTIDO	7897832863865	200 x 30 x 70	0		7897832863872	370 x 265 x 215	0	1	10	3926.10.00
8800.VP.0030	ESTOJO MULTIUSO LINHO SERENA VERDE PASTEL	7897832863889	200 x 30 x 70	0		7897832863896	370 x 265 x 215	0	1	10	3926.10.00
8800.WP.0030	ESTOJO MULTIUSO LINHO SERENA ROSA PASTEL	7897832863902	200 x 30 x 70	0		7897832863919	370 x 265 x 215	0	1	10	3926.10.00
8801.AU.0030	ESTOJO MULTIUSO SECRETS OURO	7897832870016	200 x 30 x 70	0		7897832870023	370 x 265 x 215	0	1	10	3926.10.00
8801.P.0030	ESTOJO MULTIUSO SECRETS PRETO	7897832869997	200 x 30 x 70	0		7897832870009	370 x 265 x 215	0	1	10	3926.10.00
8801.S.0030	ESTOJO MULTIUSO SECRETS SORTIDO	7897832870412	200 x 30 x 70	0		7897832870429	370 x 265 x 215	0	1	10	3926.10.00
8801.W.0030	ESTOJO MULTIUSO SECRETS ROSA	7897832870030	200 x 30 x 70	0		7897832870047	370 x 265 x 215	0	1	10	3926.10.00
8805.C.0030	ESTOJO MULTIUSO FULL COLOR AZUL	7897832890700	200 x 30 x 70	0		7897832890717	370 x 265 x 215	0	1	10	3926.10.00
8805.Q.0030	ESTOJO MULTIUSO FULL COLOR PINK	7897832890724	200 x 30 x 70	0		7897832890731	370 x 265 x 215	0	1	10	3926.10.00
8805.R.0030	ESTOJO MULTIUSO FULL COLOR ROXO	7897832890748	200 x 30 x 70	0		7897832890755	370 x 265 x 215	0	1	10	3926.10.00



dello[®]
A marca da organização



Acesse nossa bio.

CONTATOS:

Escritório
(85) 3226-4218

Cel. whatsapp
(85) 9 8974-4218

Acesso rápido



  | **fenixfort**
www.fenixfort.com.br

email: fenixfort@fenixfort.com.br